

SCHMETZ



**Nadeln für Haushalt-Nähmaschinen,
Spezial-Anwendungen
und Overlock**

**Needles for Home Sewing Machines,
Special Applications
and Overlock**

**Agujas para Maquinas de Coser Domesticas,
Aplicaciones Especiales
y Overlock**

**Aiguilles pour machines à coudre domestiques,
applications spéciales
et overlock**

SCHMETZ Colour Coding

For quick identification of needle size and type/application, the below mentioned SCHMETZ household needles are manufactured with a colour code printed on the needle shoulder. The first colour identifies the application, the second colour the needle size (see illustration).

Needle Type/Application



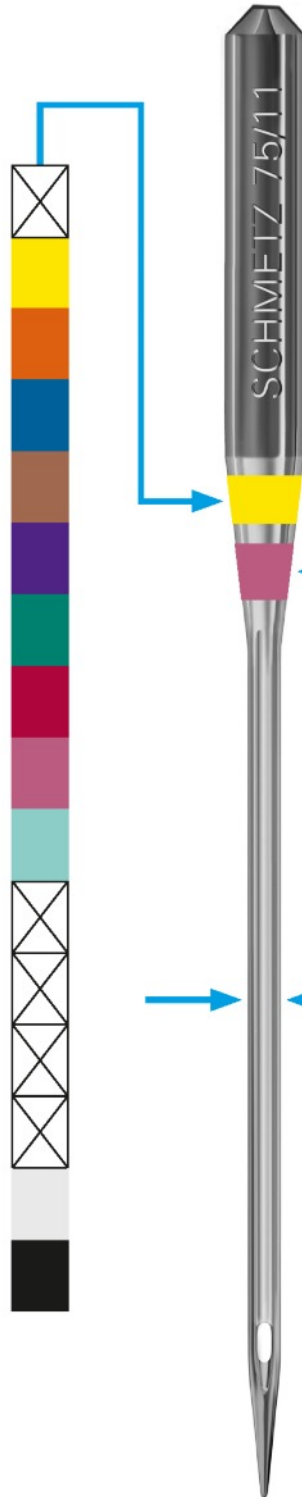

- Universal
- Stretch
- Jersey
- Jeans
- Leather
- Microtex
- Quilting
- Embroidery
- Metallic
- Topstitch
- Embroidery Spring Needle
- Hemstitch
- Double Eye Needle
- Quick Threading Needle
- Special Needles
(HAX1SP, 130/705 H-PS, 705 B)
- Overlock Needles
(ELx705, ELx705 CF, ELx705 SUK CF)





Needle Size







NM	SIZE
130	21
125	20
120	19
110	18
100	16
90	14
80	12
75	11
70	10
65	9
60	8

Note:  No application colour code. Only the needle size is colour coded.

TYP TYPE TIPO TYPE	CODE	INHALT DER BOXEN CONTENT OF BOXES CONTENIDO DE LAS CAJAS CONTENU DES BOÎTES	PRICE GROUP-CODE	 Refill = 30 B5 Box ----- Pack of 150 needles	 SB-Card =10 cards with B5 Box Carton of 50 needles ----- SB-Card = 20 cards with B5 Box Carton of 100 needles	 Refill = 30 B10 Box ----- Pack of 300 needles	 SB-Card = 10 cards with B10 Box Carton of 100 needles ----- SB-Card = 20 cards with B10 Box Carton of 200 needles	 MAGAZINE incl. Refill of 30 boxes ----- 150 300 needles
-----------------------------	------	--	------------------	---	--	--	---	---







CANU 22:15 2				 130/705 H / 15x1 H UNIVERSAL					
B 5	VAS	5 x NM 60	DA	X	X			X	
B 5	VJS	5 x NM 65	DA	X	X			X	
B 5	VBS	5 x NM 70	DA	X	X			X	
B 5	VMS	5 x NM 75	DA	X	X			X	
B 5	VCS	5 x NM 80	DA	X	X			X	
B 5	VDS	5 x NM 90	DA	X	X			X	
B 5	VES	5 x NM 100	DA	X	X			X	
B 5	VFS	5 x NM 110	DA	X	X			X	
B 5	VGS	5 x NM 120	DA	X	X			X	
B 5	VXS	5 x NM 130	DA	X	X				
B 5	VHS	2 x NM 70, 2 x NM 80, 1 x NM 90	DA	X	X			X	
B 5	VIS	2 x NM 80, 2 x NM 90, 1 x NM 100	DA	X					
B 5	VLS	1 x NM 70, 2 x NM 80, 1 x NM 90, 1 x NM 100	DA	X	X			X	
B 5	V1S	2 x NM 70, 3 x NM 80	DA	X					
B 5	VNS	1 x NM 70, 3 x NM 80, 1 x NM 90	DA	X	X			X	
B 5	VOS	1 x NM 80, 3 x NM 90, 1 x NM 100	DA	X	X				
B 5	VRS	1 x NM 70, 2 x NM 80, 2 x NM 90	DA	X	X			X	
B 5	VYS	3 x NM 80, 2 x NM 90	DA	X	X				
B 5	VZS	2 x NM 80, 3 x NM 90	DA	X				X	

CANU 22:15 2				 130/705 H / 15x1 H UNIVERSAL					
B 10	XAS	10 x NM 60	EB			X	X		X
B 10	XJS	10 x NM 65	EB			X	X		X
B 10	XBS	10 x NM 70	EB			X	X		X
B 10	XMS	10 x NM 75	EB			X	X		X
B 10	XCS	10 x NM 80	EB			X	X		X
B 10	XDS	10 x NM 90	EB			X	X		X
B 10	XES	10 x NM 100	EB			X	X		X
B 10	XFS	10 x NM 110	EB			X	X		X
B 10	XGS	10 x NM 120	EB			X	X		X
B 10	XHS	4 x NM 70, 4 x NM 80, 2 x NM 90	EB			X	X		X
B 10	XKS	2 x NM 70, 3 x NM 80, 3 x NM 90, 2 x NM 100	EB			X	X		X
B 10	XNS	2 x NM 70, 6 x NM 80, 2 x NM 90	EB			X	X		X
B 10	XOS	3 x NM 70, 3 x NM 80, 2 x NM 90, 1 x NM 100, 1x NM 110	EB			X	X		
B 10	XTS	1 x NM 60, 3 x NM 70, 2 x NM 80, 2 x NM 90, 1 x NM 100, 1 x NM 110	EB			X	X		X
B 10	XXS	10 x NM 130	EB			X	X		

TYP TYPE TIPO TYPE	CODE	INHALT DER BOXEN CONTENT OF BOXES CONTENIDO DE LAS CAJAS CONTENU DES BOÎTES	PRICE GROUP-CODE						
				Refill = 30 B5 Box ----- Pack of 150 needles	SB-Card =10 cards with B5 Box Carton of 50 needles ----- SB-Card = 20 cards with B5 Box Carton of 100 needles	Refill = 30 B10 Box ----- Pack of 300 needles	SB-Card = 10 cards with B10 Box Carton of 100 needles ----- SB-Card = 20 cards with B10 Box Carton of 200 needles	MAGAZINE incl. Refill of 30 boxes ----- 150 300 needles	

CANU 22:15 2		 130/705 H / 15x1 H UNIVERSAL							
B 4	QPS	2 x NM 70, 2x NM 80	DV	30 boxes B4 pack of 120 needles					
B 4	QZS	2 x NM 80, 2 x NM 90	FA	30 boxes B4 pack of 120 needles					
B 3	TDS	3 x NM 90	FC	30 boxes B3 pack of 90 needles					

CANU 22:15 2		130/705 H SORT. / ASSORT. / COMBINADA COMBI - BOX							
B 5	KQS	2 x 130/705 H NM 90, 1 x 130/705 H WING NM 100, 2 x 130/705 H-E NM 75	DT	x					
B 5	V5S	2 x 130/705 H NM 75, 1 x 130/705 H NM 80, 1 x 130/705 H NM 90, 1 x 130/705 H-S NM 75	DB	x					
B 5	V6S	4 x 130/705 H NM 90, 1 x 130/705 H-S NM 75	DB	x					
B 5	V7S	2 x 130/705 H NM 75, 2 x 130/705 H NM 90, 1 x 130/705 H-S NM 75	DB	x					
B 5	VSS	2 x 130/705 H NM 80, 1 x 130/705 H NM 90, 1 x 130/705 H NM 100, 1 x 130/705 H-PS NM 75	DP	x					
B 5	VVS	1 x 130/705 H NM 70, 1 x 130/705 H NM 80, 1 x 130/705 H NM 90, 1 x 130/705 H-J NM 90, 1 x 130/705 H-S NM 90	DO	x	x				
B 8+1	KNS	1 x 130/705 H NM 70, 2 x 130/705 H NM 80, 1 x 130/705 H NM 90, 1 x 130/705 H-J NM 90, 1 x 130/705 H-J NM 100, 1 x 130/705 H-S NM 75, 1 x 130/705 H-S NM 90, 1 x 130/705 H ZWI NM 80 NE 2.0	EA			30 boxes B8+1 pack of 270 needles	10 boxes B8+1 pack of 90 needles ----- 20 boxes B8+1 pack of 180 needles		





TYP TYPE TIPO TYPE	CODE	INHALT DER BOXEN CONTENT OF BOXES CONTENIDO DE LAS CAJAS CONTENU DES BOÎTES	PRICE GROUP-CODE						
				Refill = 30 B5 Box ----- Pack of 150 needles	SB-Card =10 cards with B5 Box Carton of 50 needles ----- SB-Card = 20 cards with B5 Box Carton of 100 needles	Refill = 30 B10 Box ----- Pack of 300 needles	SB-Card = 10 cards with B10 Box Carton of 100 needles ----- SB-Card = 20 cards with B10 Box Carton of 200 needles	MAGAZINE incl. Refill of 30 boxes ----- 150 300 needles	

CANU 22:15 2		130/705 H SORT. / ASSORT. / COMBINADA COMBI - BOX							
B 8+1	KOS	1 x 130/705 H NM 70, 2 x 130/705 H NM 80, 1 x 130/705 H NM 90, 1 x 130/705 H WING NM 100, 1 x 130/705 H-E NM 90, 1 x 130/705 H-J NM 90, 1 x 130/705 H-S NM 75, 1 x 130/705 H-S NM 90	EA				30 boxes B8+1 pack of 270 needles		
B 8+1	KPS	1 x 130/705 H NM 70, 2 x 130/705 H NM 80, 1 x 130/705 H NM 90, 1 x 130/705 H WING NM 100, 1 x 130/705 H-J NM 90, 1 x 130/705 H-J NM 100, 1 x 130/705 H-S NM 75, 1 x 130/705 H-S NM 90	EA				30 boxes B8+1 pack of 270 needles		
B 10	XVS	2 x 130/705 H NM 70, 3 x 130/705 H NM 80, 1 x 130/705 H NM 90, 1 x 130/705 H-J NM 90, 1 x 130/705 H-J NM 100, 1 x 130/705 H-S NM 75, 1 x 130/705 H-S NM 90	EI				x		

CANU 22:15 2		HAX1 SORT. / ASSORT. / COMBINADA COMBI - BOX							
B 5	V8S	1 x 130/705 H NM 75, 1 x 130/705 H NM 90, 1 x 130/705 H NM 100, 1 x HAX1 SP NM 75, 1 x HAX1 SP NM 90	DU	x					

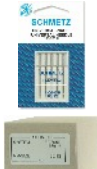
CANU 03:33 1		DCx1 SORT. / ASSORT. / COMBINADA OVERLOCK / SERGER							
B 5	VTS	2 x NM 75, 3 x NM 90	DI	x	x				

CANU 03:34 2		DCx1F FLACHKOLBEN / FLATTENED SHANK / CABO PLANO / TALON PLAT OVERLOCK / SERGER							
B 10	XMS	10 x NM 75	EH			x	x		
B 10	XDS	10 x NM 90	EH			x	x		

TYP TYPE TIPO TYPE	CODE	INHALT DER BOXEN CONTENT OF BOXES CONTENIDO DE LAS CAJAS CONTENU DES BOÎTES	PRICE GROUP-CODE						
				Refill = 30 B5 Box ----- Pack of 150 needles	SB-Card =10 cards with B5 Box Carton of 50 needles ----- SB-Card = 20 cards with B5 Box Carton of 100 needles	Refill = 30 B10 Box ----- Pack of 300 needles	SB-Card = 10 cards with B10 Box Carton of 100 needles ----- SB-Card = 20 cards with B10 Box Carton of 200 needles	MAGAZINE incl. Refill of 30 boxes ----- 150 300 needles	

CANU 08:90 2				130 N NACHSTICKEN / TOPSTITCH					
B 5	VBS	5 x NM 70	DK	x	x				
B 5	VCS	5 x NM 80	DK	x	x				
B 5	VDS	5 x NM 90	DK	x	x				
B 5	VES	5 x NM 100	DK	x	x				
B 5	VFS	5 x NM 110	DK	x	x				
B 5	VIS	2 x NM 80, 2 x NM 90, 1 x NM 100	DK	x	x				

CANU 08:91 2				130 MET METALLIC					
B 5	VCS	5 x NM 80	DK	x	x			x	
B 5	VDS	5 x NM 90	DK	x	x			x	

CANU 10:08EB1				BLx1 OVERLOCK / SERGER					
B 5	VTS	2 x NM 75, 3 x NM 90	DI	x	x				





CANU 12:31 2				SY 2054/16x75 OVERLOCK / SERGER					
B 10	XBS	10 x NM 70	EL			x	x		
B 10	XCS	10 x NM 80	EL			x	x		
B 10	XDS	10 x NM 90	EL			x	x		

CANU 12:31FB2				SY 2054 SUK/16x75 SUK OVERLOCK / SERGER					
B 10	XCS	10 x NM 80	EL			x	x		

CANU 14:24 1				DBx1/1738 RUNDKOLBEN / ROUND SHANK / CABO REDONDO / TALON ROND					
B 5	VJS	5 x NM 65	DM	x					
B 5	VMS	5 x NM 75	DM	x					
B 5	VDS	5 x NM 90	DM	x					
B 5	VES	5 x NM 100	DM	x					
B 5	VFS	5 x NM 110	DM	x					

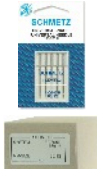
CANU 14:24EB1				DBx1 SES JERSEY RUNDKOLBEN / ROUND SHANK / CABO REDONDO / TALON ROND					
B 5	VJS	5 x NM 65	DM	x					
B 5	VMS	5 x NM 75	DM	x					
B 5	VDS	5 x NM 90	DM	x					

CANU 14:25 1				287 WH/1738 RUNDKOLBEN / ROUND SHANK / CABO REDONDO / TALON ROND					
B 5	VAS	5 x NM 60	DM	x	x			x	
B 5	VBS	5 x NM 70	DM	x	x			x	

TYP TYPE TIPO TYPE	CODE	INHALT DER BOXEN CONTENT OF BOXES CONTENIDO DE LAS CAJAS CONTENU DES BOÎTES	PRICE GROUP-CODE						
				Refill = 30 B5 Box ----- Pack of 150 needles	SB-Card =10 cards with B5 Box Carton of 50 needles ----- SB-Card = 20 cards with B5 Box Carton of 100 needles	Refill = 30 B10 Box ----- Pack of 300 needles	SB-Card = 10 cards with B10 Box Carton of 100 needles ----- SB-Card = 20 cards with B10 Box Carton of 200 needles		MAGAZINE incl. Refill of 30 boxes ----- 150 300 needles





CANU 287 WH/1738				14:25 1 RUNDKOLBEN / ROUND SHANK / CABO REDONDO / TALON ROND					
B 5	VCS	5 x NM 80	DM	X	X			X	
B 5	VDS	5 x NM 90	DM	X	X			X	
B 5	VES	5 x NM 100	DM	X	X			X	
B 5	VFS	5 x NM 110	DM	X	X			X	
B 5	VHS	2 x NM 70, 2 x NM 80, 1 x NM 90	DM	X	X			X	
B 5	VKS	1 x NM 60, 1 x NM 70, 2 x NM 80, 1 x NM 90	DM	X	X				
B 5	VLS	1 x NM 70, 2 x NM 80, 1 x NM 90, 1 x NM 100	DM	X	X			X	
B 10	XBS	1 x NM 70	EF			X	X		X
B 10	XCS	1 x NM 80	EF			X	X		X
B 10	XDS	1 x NM 90	EF			X	X		X
B 10	XES	1 x NM 100	EF			X	X		X
B 10	XFS	1 x NM 110	EF			X	X		X
B 10	XHS	4 x NM 70, 4 x NM 80, 2 x NM 90	EF			X	X		X

CANU DBx2 LEATHER				14:25AX1 RUNDKOLBEN / ROUND SHANK / CABO REDONDO / TALON ROND					
B 5		VDS	5 x NM 90	DE	X				
B 5		VES	5 x NM 100	DE	X				
B 5		VFS	5 x NM 110	DE	X				

CANU HLx5 SCHNELLNÄHER SPEZIALNADEL / HIGH SPEED SPECIAL NEEDLE /				18:60 12 AGUJA ESPECIAL ALTA VELOCIDAD / AIGUILLE PIQUEUSE RAPIDE					
B 5	VMS	5 x NM 75	DE	X	X				
B 5	VDS	5 x NM 90	DE	X	X				
B 5	VES	5 x NM 100	DE	X	X				
B 5	V3S	3 x NM 75, 2 x NM 90	DE	X	X				
B 10	XMS	10 x NM 75	EE			X	X		
B 10	XDS	10 x NM 90	EE			X	X		
B 10	XES	10 x NM 100	EE			X	X		

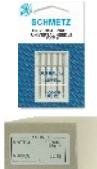
CANU 135x5 MR LONG ARM QUILTING				20:05 1M QUILTER AVEC BRAS LONG / PESPUNTEAR CON BRAZO LARGO					
B 5	VES	5 x MR 3.5 (= NM 100 = size 16)	DE	X	X				
B 5	VFS	5 x MR 4.0 (= NM 110 = size 18)	DE	X	X				
B 5	VGS	5 x MR 4.5 (= NM 120 = size 19)	DE	X	X				
B 5	V9S	5 x MR 5.0 (= NM 130 = size 21)	DE	X	X				

CANU 705 HDK				21:37 2 ÖHRSCHLITZ / QUICK THREADING / ENHEBRADO RAPIDO / ENFILAGE FACILE					
B 5	VCS	5 x NM 80	DR	X	X			X	
B 5	VDS	5 x NM 90	DR	X	X			X	

TYP TYPE TIPO TYPE	CODE	INHALT DER BOXEN CONTENT OF BOXES CONTENIDO DE LAS CAJAS CONTENU DES BOÎTES	PRICE GROUP-CODE						
				Refill = 30 B5 Box ----- Pack of 150 needles	SB-Card = 10 cards with B5 Box Carton of 50 needles ----- SB-Card = 20 cards with B5 Box Carton of 100 needles	Refill = 30 B10 Box ----- Pack of 300 needles	SB-Card = 10 cards with B10 Box Carton of 100 needles ----- SB-Card = 20 cards with B10 Box Carton of 200 needles	MAGAZINE incl. Refill of 30 boxes ----- 150 300 needles	

CANU 21:44 2				705 B (BERNINA)					
B 5	VCS	5 x NM 80	DA	X	X			X	
B 5	VDS	5 x NM 90	DA	X	X			X	
B 10	XCS	10 x NM 80	EB			X	X		







CANU 21:46 5				BLx4N/JLx2 OVERLOCK / SERGER					
B 10	XMS	10 x NM 75	EH			X	X		
B 10	XDS	10 x NM 90	EH			X	X		

CANU 22:15AS2				130/705 H LL/15x2 N TW LEDER / LEATHER / CUERO / CUIR					
B 5	VBS	5 x NM 70	DE	X	X			X	
B 5	VCS	5 x NM 80	DE	X	X			X	
B 5	VDS	5 x NM 90	DE	X	X			X	
B 5	VES	5 x NM 100	DE	X	X			X	
B 5	VFS	5 x NM 110	DE	X	X			X	
B 5	VGS	5 x NM 120	DE	X	X			X	
B 5	VIS	2 x NM 80, 2 x NM 90, 1 x NM 100	DE	X	X			X	

CANU 22:15FB2				130/705 H SUK JERSEY					
B 5	VBS	5 x NM 70	DG	X	X			X	
B 5	VCS	5 x NM 80	DG	X	X			X	
B 5	VDS	5 x NM 90	DG	X	X			X	
B 5	VES	5 x NM 100	DG	X	X			X	
B 5	VHS	2 x NM 70, 2 x NM 80, 1 x NM 90	DG	X	X			X	
B 5	VLS	1 x NM 70, 2 x NM 80, 1 x NM 90, 1 x NM 100	DG	X	X			X	
B 10	XBS	10 x NM 70	ED			X	X		X
B 10	XCS	10 x NM 80	ED			X	X		X
B 10	XDS	10 x NM 90	ED			X	X		X
B 10	XHS	4 x NM 70, 4 x NM 80, 2 x NM 90	ED			X	X		X

CANU 22:16 2				705 DE DOPPELÖHR / DOUBLE EYE / DOBLE OJAL / DOUBLE CHAS					
B 5	VCS	5 x NM 80	DL	X	X				

CANU 22:20 2				130/705 H WING HOHLSAUM / HEMSTITCH / CALADOS / OURLET A JOUR					
B 1	SES	1 x NM 100	AD	30 boxes B1 pack of 30 needles	10 boxes B1 pack of 10 needles 20 boxes B1 pack of 20 needles				

TYP TYPE TIPO TYPE	CODE	INHALT DER BOXEN CONTENT OF BOXES CONTENIDO DE LAS CAJAS CONTENU DES BOÎTES	PRICE GROUP-CODE	 Refill = 30 B5 Box ----- Pack of 150 needles	 SB-Card = 10 cards with B5 Box Carton of 50 needles ----- SB-Card = 20 cards with B5 Box Carton of 100 needles	 Refill = 30 B10 Box ----- Pack of 300 needles	 SB-Card = 10 cards with B10 Box Carton of 100 needles ----- SB-Card = 20 cards with B10 Box Carton of 200 needles	 MAGAZINE incl. Refill of 30 boxes ----- 150 300 needles	
-----------------------------	------	--	------------------	---	---	--	---	--	--

CANU 22:20 2  **130/705 H WING**
HOHLSAUM / HEMSTITCH / CALADOS / OURLET A JOUR

B 2	DES	2 x NM 100	BD	30 boxes B2 pack of 60 needles	10 boxes B2 pack of 20 needles 20 boxes B2 pack of 40 needles				
B 1	SGS	1 x NM 120	AD	30 boxes B1 pack of 30 needles	10 boxes B1 pack of 10 needles 20 boxes B1 pack of 20 needles				

CANU 22:30FB2  **130/705 H-J**
JEANS / DENIM / TEJANO

B 5	VBS	5 x NM 70	DF	X	X			X	
B 5	VCS	5 x NM 80	DF	X	X			X	
B 5	VDS	5 x NM 90	DF	X	X			X	
B 5	VES	5 x NM 100	DF	X	X			X	
B 5	VFS	5 x NM 110	DF	X	X			X	
B 5	VVS	2 x NM 90, 2 x NM 100, 1 x NM 110	DF	X	X			X	

CANU 22:31MA2  **130/705 H-M**
MICROTEX





B 5	VAS	5 x NM 60	DF	X	X			X	
B 5	VBS	5 x NM 70	DF	X	X			X	
B 5	VCS	5 x NM 80	DF	X	X			X	
B 5	VDS	5 x NM 90	DF	X	X			X	
B 5	VES	5 x NM 100	DF	X	X			X	
B 5	VFS	5 x NM 110	DF	X	X			X	
B 5	V4S	2 x NM 60, 2 x NM 70, 1 x NM 80	DF	X	X			X	

CANU 22:32 2  **130/705 H-Q**
STEPPEN / QUILTING / PESPUNTEAR

B 5	VMS	5 x NM 75	DE	X	X			X	
B 5	VDS	5 x NM 90	DE	X	X			X	
B 5	V3S	3 x NM 75, 2 x NM 90	DE	X	X			X	

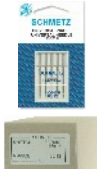
CANU 22:40 1  **ELx705 CF VERCHROMT / CHROME FINISH / CROMADA / CHROME**
OVERLOCK / SERGER

B 5	VJS	5 x NM 65	DL	X	X				
B 5	VCS	5 x NM 80	DL	X	X				
B 5	VDS	5 x NM 90	DL	X	X				
B 5	VZS	2 x NM 80, 3 x NM 90	DL	X	X				

TYP TYPE TIPO TYPE	CODE	INHALT DER BOXEN CONTENT OF BOXES CONTENIDO DE LAS CAJAS CONTENU DES BOÎTES	PRICE GROUP-CODE						
				Refill = 30 B5 Box ----- Pack of 150 needles	SB-Card =10 cards with B5 Box Carton of 50 needles ----- SB-Card = 20 cards with B5 Box Carton of 100 needles	Refill = 30 B10 Box ----- Pack of 300 needles	SB-Card = 10 cards with B10 Box Carton of 100 needles ----- SB-Card = 20 cards with B10 Box Carton of 200 needles	MAGAZINE incl. Refill of 30 boxes ----- 150 300 needles	

CANU 22:40FB1				ELx705 SUK CF VERCHROMT / CHROME FINISH / CROMADA / CHROME OVERLOCK / SERGER					
B 5	VJS	5 x NM 65	DL	X	X				
B 5	VCS	5 x NM 80	DL	X	X				
B 5	VDS	5 x NM 90	DL	X	X				
B 5	VZS	2 x NM 80, 3 x NM 90	DL	X	X				

CANU 22:40 2				ELx705 OVERLOCK / SERGER					
B 5	VCS	5 x NM 80	DL	X	X				
B 5	VDS	5 x NM 90	DL	X	X				
B 5	VZS	2 x NM 80, 3 x NM 90	DL	X	X				





CANU 22:70EB2				130/705 H-E STICKEN / EMBROIDERY / BORDADO / BRODER					
B 5	VMS	5 x NM 75	DE	X	X			X	
B 5	VDS	5 x NM 90	DE	X	X			X	
B 5	V3S	3 x NM 75, 2 x NM 90	DE	X	X			X	

CANU 22:70EB9				130/705 H-ET GOLD EMBROIDERY / STICKEN TITAN NITRID / TITANIUM NITRIDE / DORADA / DOREE					
B 5	VMS	5 x NM 75	DW	X	X				
B 5	VDS	5 x NM 90	DW	X	X				

CANU 22:80FB2				130/705 H-S STRETCH					
B 5	VJS	5 x NM 65	DE	X	X			X	
B 5	VMS	5 x NM 75	DE	X	X			X	
B 5	VDS	5 x NM 90	DE	X	X			X	
B 5	VQS	2 x NM 65, 2 x NM 75, 1 x NM 90	DE	X	X			X	
B 5	V3S	3 x NM 75, 2 x NM 90	DE	X	X			X	

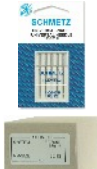
CANU 22:81FB2				130/705 H-PS PFAFF-STRETCH					
B 5	VMS	5 x NM 75	DE	X	X			X	
B 5	VDS	5 x NM 90	DE	X	X				

CANU 22:81FB2				130/705 H-PS SORT. / ASSORT. PFAFF-STRETCH COMBI - BOX					
B 10	XSS	4 x 130/705 H-PS NM 75, 4 x 130/705 H-PS NM 90, 2 x 130/705 H-J NM 100	EK			X			







TYP TYPE TIPO TYPE	CODE	INHALT DER BOXEN CONTENT OF BOXES CONTENIDO DE LAS CAJAS CONTENU DES BOÎTES	PRICE GROUP-CODE						
				Refill = 30 B5 Box ----- Pack of 150 needles	SB-Card = 10 cards with B5 Box Carton of 50 needles ----- SB-Card = 20 cards with B5 Box Carton of 100 needles	Refill = 30 B10 Box ----- Pack of 300 needles	SB-Card = 10 cards with B10 Box Carton of 100 needles ----- SB-Card = 20 cards with B10 Box Carton of 200 needles	MAGAZINE incl. Refill of 30 boxes ----- 150 300 needles	

CANU 22:82FB1 HAx1 SP SUPER STRETCH									
B 5	VJS	5 x NM 65	DE	X	X				
B 5	VMS	5 x NM 75	DE	X	X				
B 5	VDS	5 x NM 90	DE	X	X				
B 5	VTS	2 x NM 75, 3 x NM 90	DE	X	X				

CANU 22:85 8 130/705 H-SU SUPER UNIVERSAL									
B 5 new	VBS	5 x NM 70	DW	X	X				
B 5 new	VCS	5 x NM 80	DW	X	X				
B 5 new	VDS	5 x NM 90	DW	X	X				
B 5 new	VES	5 x NM 100	DW	X	X				







CANU 64:25 2 130 MET ZWI METALLIC ZWILLING / TWIN / GEMELA / DOUBLE									
B 1	SCS	1 x NM 80 NE 2,5	AG	30 boxes B1 pack of 30 needles	10 boxes B1 pack of 10 needles 20 boxes B1 pack of 20 needles				
B 1	SDS	1 x NM 90 NE 3,0	AG	30 boxes B1 pack of 30 needles	10 boxes B1 pack of 10 needles 20 boxes B1 pack of 20 needles				

CANU 69:25FB2 130/705 H-S ZWI STRETCH ZWILLING / TWIN / GEMELA / DOUBLE									
B 1	SMS	1 x NM 75 NE 2,5	AG	30 boxes B1 pack of 30 needles	10 boxes B1 pack of 10 needles 20 boxes B1 pack of 20 needles			30 boxes B1 pack of 30 needles	
B 2	DMS	2 x NM 75 NE 2,5	BF	30 boxes B2 pack of 60 needles	10 boxes B2 pack of 20 needles 20 boxes B2 pack of 40 needles			30 boxes B2 pack of 60 needles	
B 1	SMS	1 x NM 75 NE 4,0	AG	30 boxes B1 pack of 30 needles	10 boxes B1 pack of 10 needles 20 boxes B1 pack of 20 needles			30 boxes B1 pack of 30 needles	

TYP TYPE TIPO TYPE	CODE	INHALT DER BOXEN CONTENT OF BOXES CONTENIDO DE LAS CAJAS CONTENU DES BOÎTES	PRICE GROUP-CODE	 Refill = 30 B5 Box ----- Pack of 150 needles	 SB-Card = 10 cards with B5 Box Carton of 50 needles ----- SB-Card = 20 cards with B5 Box Carton of 100 needles	 Refill = 30 B10 Box ----- Pack of 300 needles	 SB-Card = 10 cards with B10 Box Carton of 100 needles ----- SB-Card = 20 cards with B10 Box Carton of 200 needles	 MAGAZINE incl. Refill of 30 boxes ----- 150 300 needles	
-----------------------------	------	--	------------------	---	---	--	---	---	--







**CANU 130/705 H ZWI
ZWILLING / TWIN / DOUBLE / GEMELA**

69:40FB2	B 2	DMS	2 x NM 75 NE 4,0	BF	30 boxes B2 pack of 60 needles	10 boxes B2 pack of 20 needles 20 boxes B2 pack of 40 needles			30 boxes B2 pack of 60 needles	
70:16 2	B 1	SBS	1 x NM 70 NE 1,6	AE	30 boxes B1 pack of 30 needles	10 boxes B1 pack of 10 needles 20 boxes B1 pack of 20 needles			30 boxes B1 pack of 30 needles	
70:16 2	B 2	DBS	2 x NM 70 NE 1,6	BE	30 boxes B2 pack of 60 needles	10 boxes B2 pack of 20 needles 20 boxes B2 pack of 40 needles			30 boxes B2 pack of 60 needles	
70:16 2	B 1	SCS	1 x NM 80 NE 1,6	AE	30 boxes B1 pack of 30 needles	10 boxes B1 pack of 10 needles 20 boxes B1 pack of 20 needles			30 boxes B1 pack of 30 needles	
70:16 2	B 2	DCS	2 x NM 80 NE 1,6	BE	30 boxes B2 pack of 60 needles	10 boxes B2 pack of 20 needles 20 boxes B2 pack of 40 needles			30 boxes B2 pack of 60 needles	
70:20 2	B 1	SCS	1 x NM 80 NE 2,0	AA	30 boxes B1 pack of 30 needles	10 boxes B1 pack of 10 needles 20 boxes B1 pack of 20 needles			30 boxes B1 pack of 30 needles	
70:20 2	B 2	DCS	2 x NM 80 NE 2,0	BA	30 boxes B2 pack of 60 needles	10 boxes B2 pack of 20 needles 20 boxes B2 pack of 40 needles			30 boxes B2 pack of 60 needles	
70:20 2	B 3	TCS	3 x NM 80 NE 2,0	CA	30 boxes B3 pack of 90 needles	10 boxes B3 pack of 30 needles 20 boxes B3 pack of 60 needles			30 boxes B3 pack of 90 needles	

TYP TYPE TIPO TYPE	CODE	INHALT DER BOXEN CONTENT OF BOXES CONTENIDO DE LAS CAJAS CONTENU DES BOÎTES	PRICE GROUP-CODE						
				Refill = 30 B5 Box ----- Pack of 150 needles	SB-Card = 10 cards with B5 Box Carton of 50 needles ----- SB-Card = 20 cards with B5 Box Carton of 100 needles	Refill = 30 B10 Box ----- Pack of 300 needles	SB-Card = 10 cards with B10 Box Carton of 100 needles ----- SB-Card = 20 cards with B10 Box Carton of 200 needles	MAGAZINE incl. Refill of 30 boxes ----- 150 300 needles	

**CANU 130/705 H ZWI
ZWILLING / TWIN / DOUBLE / GEMELA**

70:25 2	B 1	SCS	1 x NM 80 NE 2,5	AA	30 boxes B1 pack of 30 needles	10 boxes B1 pack of 10 needles 20 boxes B1 pack of 20 needles			30 boxes B1 pack of 30 needles
70:25 2	B 2	DCS	2 x NM 80 NE 2,5	BA	30 boxes B2 pack of 60 needles	10 boxes B2 pack of 20 needles 20 boxes B2 pack of 40 needles			30 boxes B2 pack of 60 needles
70:30 2	B 1	SDS	1 x NM 90 NE 3,0	AA	30 boxes B1 pack of 30 needles	10 boxes B1 pack of 10 needles 20 boxes B1 pack of 20 needles			30 boxes B1 pack of 30 needles
70:30 2	B 2	DDS	2 x NM 90 NE 3,0	BA	30 boxes B2 pack of 60 needles	10 boxes B2 pack of 20 needles 20 boxes B2 pack of 40 needles			30 boxes B2 pack of 60 needles
70:40 2	B 1	SCS	1 x NM 80 NE 4,0	AA	30 boxes B1 pack of 30 needles	10 boxes B1 pack of 10 needles 20 boxes B1 pack of 20 needles			30 boxes B1 pack of 30 needles
70:40 2	B 2	DCS	2 x NM 80 NE 4,0	BA	30 boxes B2 pack of 60 needles	10 boxes B2 pack of 20 needles 20 boxes B2 pack of 40 needles			30 boxes B2 pack of 60 needles
70:40 2	B 1	SDS	1 x NM 90 NE 4,0	AA	30 boxes B1 pack of 30 needles	10 boxes B1 pack of 10 needles 20 boxes B1 pack of 20 needles			30 boxes B1 pack of 30 needles
70:40 2	B 2	DDS	2 x NM 90 NE 4,0	BA	30 boxes B2 pack of 60 needles	10 boxes B2 pack of 20 needles 20 boxes B2 pack of 40 needles			30 boxes B2 pack of 60 needles
70:40 2	B 1	SES	1 x NM 100 NE 4,0	AA	30 boxes B1 pack of 30 needles	10 boxes B1 pack of 10 needles 20 boxes B1 pack of 20 needles			30 boxes B1 pack of 30 needles

TYP TYPE TIPO TYPE	CODE	INHALT DER BOXEN CONTENT OF BOXES CONTENIDO DE LAS CAJAS CONTENU DES BOÎTES	PRICE GROUP-CODE						
				Refill = 30 B5 Box ----- Pack of 150 needles	SB-Card = 10 cards with B5 Box Carton of 50 needles ----- SB-Card = 20 cards with B5 Box Carton of 100 needles	Refill = 30 B10 Box ----- Pack of 300 needles	SB-Card = 10 cards with B10 Box Carton of 100 needles ----- SB-Card = 20 cards with B10 Box Carton of 200 needles	MAGAZINE incl. Refill of 30 boxes ----- 150 300 needles	







CANU 130/705 H ZWI ZWILLING / TWIN / DOUBLE / GEMELA									
70:40 2									
B 2	DES	2 x NM 100 NE 4,0	BA	30 boxes B2 pack of 60 needles	10 boxes B2 pack of 20 needles ----- 20 boxes B2 pack of 40 needles				30 boxes B2 ----- pack of 60 needles

CANU 130/705 H ZWI SORT. / ASSORT. ZWILLING / TWIN / GEMELA / DOUBLE									
70:16 2									
B 3	THS	1 x NM 70 NE 1,6 , 1 x NM 80 NE 2,0 , 1 x NM 90 NE 3,0	CD	30 boxes B3 pack of 90 needles	10 boxes B3 pack of 30 needles ----- 20 boxes B3 pack of 60 needles				30 boxes B3 ----- pack of 90 needles

CANU 130/705 H-J ZWI JEANS ZWILLING / TWIN / GEMELA / DOUBLE									
71:40MA2									
B 1	SES	1 x NM 100 NE 4,0	AG	30 boxes B1 pack of 30 needles	10 boxes B1 pack of 10 needles ----- 20 boxes B1 pack of 20 needles				30 boxes B1 ----- pack of 30 needles

CANU 130/705 H-E ZWI STICKEN ZWILLING / EMBROIDERY TWIN / BORDADO GEMELA / DOUBLE A BRODER									
72:20EB2									
B 1	SMS	1 x NM 75 NE 2,0	AG	30 boxes B1 pack of 30 needles	10 boxes B1 pack of 10 needles ----- 20 boxes B1 pack of 20 needles				30 boxes B1 ----- pack of 30 needles
72:30EB2									
B 1	SMS	1 x NM 75 NE 3,0	AG	30 boxes B1 pack of 30 needles	10 boxes B1 pack of 10 needles ----- 20 boxes B1 pack of 20 needles				30 boxes B1 ----- pack of 30 needles

CANU 130/705 H ZWI BR ZWILLING / TWIN / GEMELA / DOUBLE									
77:60 2									
B 1	SES	1 x NM 100 NE 6,0	AH	30 boxes B1 pack of 30 needles	10 boxes B1 pack of 10 needles ----- 20 boxes B1 pack of 20 needles				

TYP TYPE TIPO TYPE	CODE	INHALT DER BOXEN CONTENT OF BOXES CONTENIDO DE LAS CAJAS CONTENU DES BOÎTES	PRICE GROUP-CODE						
				Refill = 30 B5 Box ----- Pack of 150 needles	SB-Card =10 cards with B5 Box Carton of 50 needles ----- SB-Card = 20 cards with B5 Box Carton of 100 needles	Refill = 30 B10 Box ----- Pack of 300 needles	SB-Card = 10 cards with B10 Box Carton of 100 needles ----- SB-Card = 20 cards with B10 Box Carton of 200 needles	MAGAZINE incl. Refill of 30 boxes ----- 150 300 needles	

CANU 130/705 H ZWI BR ZWILLING / TWIN / GEMELA / DOUBLE									
77:80 2									
B 1	SES	1 x NM 100 NE 8,0	AH	30 boxes B1 pack of 30 needles	10 boxes B1 pack of 10 needles ----- 20 boxes B1 pack of 20 needles			30 boxes B1 pack of 30 needles	

CANU 130/705 H DRI DRILLING / TRIPLE									
79:25 2									
B 1	SCS	1 x NM 80 NE 2,5	AB	30 boxes B1 pack of 30 needles	10 boxes B1 pack of 10 needles ----- 20 boxes B1 pack of 20 needles				
79:25 2									
B 2	DCS	2 x NM 80 NE 2,5	BB	30 boxes B2 pack of 60 needles	10 boxes B2 pack of 20 needles ----- 20 boxes B2 pack of 40 needles				
79:30 2									
B 1	SCS	1 x NM 80 NE 3,0	AB	30 boxes B1 pack of 30 needles	10 boxes B1 pack of 10 needles ----- 20 boxes B1 pack of 20 needles				

CANU 130/705 H ZWIHO HOHLSAUM ZWILLING / DOUBLE HEMSTITCH / GEMELA PARA CALADOS / DOUBLE POUR OURLET A JOUR									
90:25 2									
B 1	SES	1 x NM 100 NE 2,5	AC	30 boxes B1 pack of 30 needles	10 boxes B1 pack of 10 needles ----- 20 boxes B1 pack of 20 needles				
90:25 2									
B 2	DES	2 x NM 100 NE 2,5	BC	30 boxes B2 pack of 60 needles	10 boxes B2 pack of 20 needles ----- 20 boxes B2 pack of 40 needles				

CANU 130/705 H SPR FEDER-STICK-NADEL / EMBROIDERY SPRING NEEDLE / AGUJA PARA BORDAR CON RESORTE / AIGUILLE A RESSORT									
99:95 2									
B 1		1 x NM 80	AB						

Bestellung / Order / Pedido / Commande

Beispiel 1 / Example 1 / Ejemplo 1 / Exemple 1







22:15 2 VCS 130/705 H/15x1 H Box B5 SB-Card

UNIVERSAL NADELN für Haushalt-Nähmaschinen in Nadeldicke 80/12, verpackt in Boxen à 5 auf SB-Karten.

UNIVERSAL NEEDLES for home sewing machines in size 80/12, packed in boxes à 5 at self-service cards.

AGUJAS UNIVERSAL para maquinas de coser domesticas en tamaño 80/12 en paquete de a 5 y con "SB" cartón

AIGUILLES UNIVERSAL pour machines à coudre domestiques en grosseur 80/12 emballées par 5 pièces sur carte "SB"

TYP TYPE TIPO TYPE	CODE	INHALT DER BOXEN CONTENT OF BOXES CONTENIDO DE LAS CAJAS CONTENU DES BOÎTES	PRICE GROUP-CODE						
CANU				130/705 H / 15x1 H					
22:15 2				UNIVERSAL					
B 5	VAS	5 x NM 60	DA	x	x			x	
B 5	VJS	5 x NM 65	DA	x	x			x	
B 5	VBS	5 x NM 70	DA	x	x			x	
B 5	VMS	5 x NM 75	DA	x	x			x	
B 5	VCS	5 x NM 80	DA	x	x			x	

Canu	Code	System	Aufmachung Packaging Presentación Présentation	Bestellmenge Ordering Quantity Cantidad de pedido Quantité commande	gesamt: 100 Nadeln total: 100 needles todo: 100 agujas total: 100 aiguilles
22:15 2	VCS	130/705 H/15x1 H	Box B5 SB-card à 20	1 (=20 cards à 5 needles)	

Beispiel 2 / Example 2 / Ejemplo 2 / Exemple 2







22:15 2 VBS 130/705 H/15x1 H Magazine incl. refill à 30 boxes

UNIVERSAL NADELN für Haushalt-Nähmaschinen in Nadeldicke 70/10, verpackt in Magazine à 30 boxes.

UNIVERSAL NEEDLES for home sewing machines in size 70/10, packed in magazine à 30 boxes.

AGUJAS UNIVERSAL para maquinas de coser Domesticas en tamaño 70/10 en paquete de a 30 y estuches.

AIGUILLES UNIVERSAL pour machines à coudre domestiques en grosseur 70/10 emballées par 30 boîtes.

TYP TYPE TIPO TYPE	CODE	INHALT DER BOXEN CONTENT OF BOXES CONTENIDO DE LAS CAJAS CONTENU DES BOÎTES	PRICE GROUP-CODE						
CANU				130/705 H / 15x1 H					
22:15 2				UNIVERSAL					
B 5	VAS	5 x NM 60	DA	x	x			x	
B 5	VJS	5 x NM 65	DA	x	x			x	
B 5	VBS	5 x NM 70	DA	x	x			x	
B 5	VMS	5 x NM 75	DA	x	x			x	
B 5	VCS	5 x NM 80	DA	x	x			x	

Canu	Code	System	Aufmachung Packaging Presentación Présentation	Bestellmenge Ordering Quantity Cantidad de pedido Quantité commande	gesamt: 100 Nadeln total: 100 needles todo: 100 agujas total: 100 aiguilles
22:15 2	VBS	130/705 H/15x1 H	Magazine incl. Refill à 30 boxes	1 (=30 boxes à 5 needles)	

Verpackungscode / Packing code / Código de empaque / Code d'emballage

Verpackungscode Packing code Código de empaque Code d'emballage

Beispiel:
Example:
Ejemplo:
Exemple:

130/705 H VBS

1. Buchstabe: Anzahl der Nadeln in der Box
1. Figure: Number of needles in box
1. Letra: Cantidad de agujas en caja
1. Lettre: Nombre d'aiguilles dans l'emballage
2. Buchstabe: Nadeldicke oder Sortierung
2. Figure: Needle size or assortment
2. Letra: Tamaño aguja o surtido
2. Lettre: Grosseur d'aiguilles ou assortiment
3. Buchstabe: Code für OEM oder SCHMETZ
3. Figure: Code for OEM or SCHMETZ
3. Letra: Código fabricante o SCHMETZ
3. Lettre: Code pour le fabricant d'équipement d'origine ou SCHMETZ

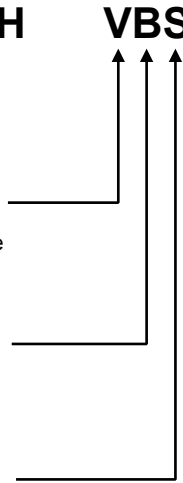

Verpackungscode - 1. Buchstabe Packing code - 1. Figure Código de empaque - 1. Letra Code d'emballage - 1. Lettre

Beispiel:
Example:
Ejemplo:
Exemple:

130/705 H VBS

1. Buchstabe: Anzahl der Nadeln in der Box
1. Figure: Number of needles in box
1. Letra: Cantidad de agujas en caja
1. Lettre: Nombre d'aiguilles dans l'emballage

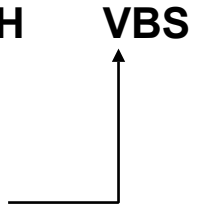

Code	Bedeutung / Meaning / Significado / Explication
S 1	Stück / pieces / piezas / pièces
D 2	Stück / pieces / piezas / pièces
T 3	Stück / pieces / piezas / pièces
Q 4	Stück / pieces / piezas / pièces
V 5	Stück / pieces / piezas / pièces
X 10	Stück / pieces / piezas / pièces
K	KOMBI Box / COMBI Box / caja combinada / emballage de combinaison

Verpackungscode - 2. Buchstabe Packing code - 2. Figure Código de empaque - 2. Letra Code d'emballage - 2. Lettre

Beispiel:
Example:
Ejemplo:
Exemple:

130/705 H VBS

2. Buchstabe: Nadeldicke oder Sortierung
2. Figure: Needle size or assortment
2. Letra: Tamaño aguja o surtido
2. Lettre: Grosseur d'aiguilles ou assortiment

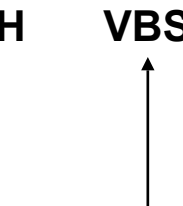

Code	Bedeutung / Meaning / Significado / Explication
A NM 60	Andere Buchstaben bzw. Zahlen stehen für eine Größensortierung.
J NM 65	
B NM 70	
M NM 75	
C NM 80	
D NM 90	Other letters or numbers stand for an assortment of sizes.
E NM 100	
F NM 110	Otras letras o números indican un tipo de combinación.
G NM 120	
9 NM 125	
X NM 130	Autres lettres ou nombres remplacent un assortiment de grosseurs d'aiguilles.

Verpackungscode - 3. Buchstabe Packing code - 3. Figure Código de empaque - 3. Letra Code d'emballage - 3. Lettre

Beispiel:
Example:
Ejemplo:
Exemple:

130/705 H VBS

3. Buchstabe: Code für OEM oder SCHMETZ
3. Figure: Code for OEM or SCHMETZ
3. Letra: Código fabricante o SCHMETZ
3. Lettre: Code pour le fabricant d'équipement d'origine ou SCHMETZ

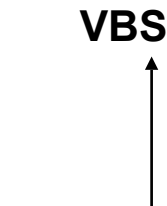

Code	Bedeutung / Meaning / Significado / Explication
S	SCHMETZ

Andere Buchstaben stehen für andere Marken.

Other letters stand for other brands.

Otras letras indican otras marcas.

Autres lettres remplacent autres marques.



SCHMETZ

Comparison of household sewing machine needle features

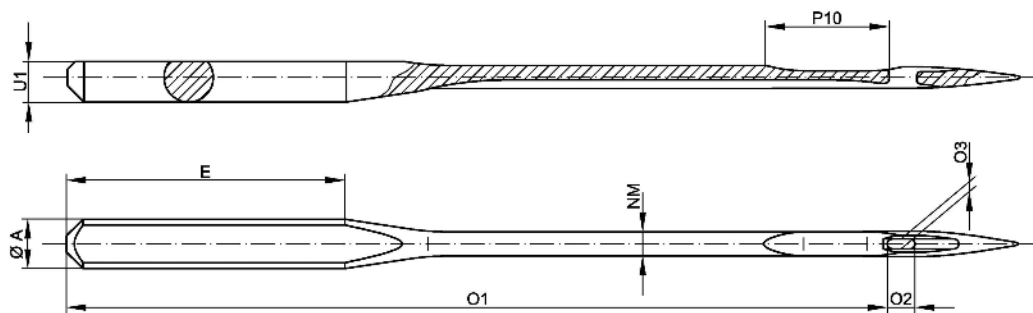

			Features										Needle size										
Canu	System	Needle type	A	O1	Eye length O2	Eye width O3	Scarf P10	Transition scarf to eye	Flattening U1	Point style	Surface	Special feature	NM 60	NM 65	NM 70	NM 75	NM 80	NM 90	NM 100	NM 110	NM 120	NM 130	
22:15 2	130/705 H	Universal	2.04	33.9	regular	regular	regular	regular	regular	slightly rounded	nickel		•	•	•	•	•	•	•	•	•	•	•
22:80FB2	130/705 H-S	Stretch	2.04	33.9	shorter	narrow	deeper	rampant	reduced	medium ball point	nickel		•			•		•					
22:15FB2	130/705 H SUK	Jersey	2.04	33.9	regular	regular	regular	regular	regular	medium ball point	nickel				•		•	•	•				
22:30FB2	130/705 H-J	Jeans	2.04	33.9	regular	regular	regular	regular	regular	medium ball point	nickel	reinforced blade				•		•	•	•	•		
22:15AS2	130/705 H LL	Leather	2.04	33.9	regular	regular	regular	regular	regular	cutting point (LL = twist point)	nickel				•		•	•	•	•	•		
22:31MA2	130/705 H-M	Microtex	2.04	33.9	regular	regular	regular	regular	regular	slim acute point	nickel	NM 60+70 reinforced blade	•			•		•	•	•	•		
22:32 2	130/705 H-Q	Quilting	2.04	33.9	regular	regular	regular	regular	regular	slightly rounded, special taper	nickel					•		•					
22:70EB2	130/705 H-E	Embroidery	2.04	33.9	larger	wide	regular	regular	regular	light ball point	nickel					•		•					
22:70EB9	130/705 H-ET	Gold Embroidery	2.04	33.9	larger	wide	regular	regular	regular	light ball point	titanium nitride					•		•					
08:91 2	130 MET	Metallic	2.04	33.5	2.00 mm	regular	regular	regular	regular	slightly rounded	nickel						•	•					
08:90 2	130 N	Topstitch	2.04	33.5	2.00 mm	regular	regular	regular	regular	slightly rounded	nickel				•		•	•	•	•			
22:85 8	130/705 H-SU	Super-Universal	2.04	33.9	larger	wide	regular	special	regular	slightly rounded	Ni-P-PTFE	reinforced blade, enlarged eye and groove, anti-adhesive surface				•		•	•	•			
99:95 2	130 H SPR	Embroidery Spring	2.04	33.9	regular	regular	regular	regular	regular	slightly rounded	nickel	spring as sewing foot					•						
22:20 2	130/705 H WING	Hemstitch	2.04	33.9	shorter	narrow	regular	regular	regular	slightly rounded	nickel	blade extended as wing								•		•	
22:16 2	705 DE	Double Eye	2.04	31.8 und 33.9	regular	wide	without	—	regular	slightly rounded	nickel	two eyes					•						
21:37 2	705 HDK	Quick Threading	2.04	33.9	shorter	regular	without	—	regular	slightly rounded	nickel	left eye wall open					•	•					

Version März 2017

UNIVERSAL NEEDLE



- **System 130/705 H**
With slightly rounded point, for trouble-free sewing of numerous types of materials.
- **Needle sizes** from NM 60 to NM 130, also assorted

Also available as TWIN and TRIPLE NEEDLE.

STRETCH NEEDLE



- **System 130/705 H-S**
With medium ball point; special eye and scarf area prevent skip stitches especially in highly elastic materials.
For elastic materials and highly elastic knitwear.
- **Needle sizes** NM 65, NM 75, NM 90, also assorted
- **Colour coding:** yellow

Also available as TWIN NEEDLE.

JERSEY NEEDLE



- **System 130/705 H-SUK**
With medium ball point, for knitted fabrics.
- **Needle sizes** NM 70 to NM 100, also assorted
- **Colour coding:** orange

JEANS NEEDLE



- **System 130/705 H-J**
The medium ball point penetrates thick and solid fabrics easier without damaging the material.
The reinforced blade causes less deflection of the needle and reduces the risk of needle breakage and skip stitches.
For denim (jeans) and similar fabrics.

Also available as TWIN NEEDLE.

- **Needle sizes** NM 70 to NM 110, also assorted
- **Colour coding:** blue

LEATHER NEEDLE

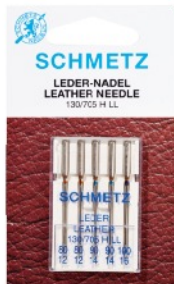

- **System 130/705 H-LL**
With cutting point (LL = twist point) for easier penetration. For leather, artificial leather and similar materials.
- **Needle sizes** NM 70 to NM 120, also assorted
- **Colour coding:** brown

Not suitable for textiles!

MICROTEX NEEDLE

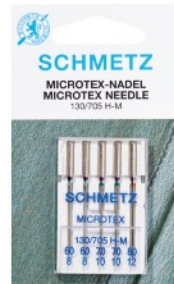

- **System 130/705 H-M**
With very slim acute point for easier piercing of very fine or densely woven fabrics.
For precise stitching of edges, also for silk, microfibre fabrics, coated materials, foils and artificial leather.
- **Needle sizes** NM 60 to NM 110, also assorted
- **Colour coding:** purple

QUILTING NEEDLE



- **System 130/705 H-Q**
Special taper to the slightly rounded point which easily penetrates the thick layers preventing damage to the material.
For quilting and patchwork.
- **Needle sizes** NM 75 and NM 90, also assorted
- **Colour coding:** green

EMBROIDERY NEEDLE



- **System 130/705 H-E**
With light ball point and especially wide eye and groove in relation to the UNIVERSAL NEEDLE to accommodate voluminous threads and woollen threads.
For embroidery.
- **Needle sizes** NM 75 and NM 90, also assorted
- **Colour coding:** red

Also available as TWIN NEEDLE.

GOLD EMBROIDERY NEEDLE



- **System 130/705 H-ET**
With light ball point and enlarged eye. Titanium Nitride coating improves needle wear resistance in high stitch count applications and reduces needle clogging.
For embroidery and coarse and densely woven materials.
- **Needle sizes** NM 75 and NM 90

METALLIC NEEDLE



- **System 130 MET**
With a very long eye (2 mm in all sizes) in comparison to the UNIVERSAL or EMBROIDERY NEEDLE.
For sewing with special effect and fancy threads, particularly for metallic threads.
- **Needle sizes** NM 80 and NM 90
- **Colour coding:** antique pink

Also available as TWIN NEEDLE.

TOPSTITCH NEEDLE



- **System 130 N**
With a very long eye (2 mm in all sizes) in comparison to the UNIVERSAL or EMBROIDERY NEEDLE.
For top and decorative stitching with multiple threads and also for replacing missing stitches in embroidery.
- **Needle sizes** NM 70 to NM 110, also assorted
- **Colour coding:** light green

EMBROIDERY SPRING NEEDLE



- **System 130/705 H-SPR**
With a spring around the needle, which assumes the function of the presser foot. For embroidering in a frame **without** presser foot, for individual patterns, free motion and better sight during embroidering.
- **Needle size** NM 80

HEMSTITCH NEEDLE



- **System 130/705 H WING**
With a "wing" on each side of the needle blade which pushes the fabric aside. For decorative seams and hemstitching in loosely woven fabrics.
- **Needle sizes NM 100 and NM 120**

Also available as **DOUBLE NEEDLE** together with a **UNIVERSAL NEEDLE**.

DOUBLE EYE NEEDLE



- **System 705 DE**
With two eyes, for decorative seams with decorative threads.
- **Needle size NM 80**

QUICK THREADING NEEDLE



- **System 705 HDK**
UNIVERSAL NEEDLE with small slip-in threading slot in the eye. Particularly suitable for easy sliding of sewing thread into the eye.
- **Needle sizes NM 80 and NM 90**

TWIN AND TRIPLE NEEDLES

Only for zigzag machines with transversal hook!

For almost every material, also TWIN NEEDLES are available. Their properties are equivalent to the single needles.

Application: Pintucks, single and multicoloured decorative seams, hems

NEEDLES FOR SPECIAL MACHINES

We provide all needle systems for domestic sergers and other special machines.

Ask your dealer for our list of "Needles for Home Sewing Machines, Special Applications and Overlock".

UNIVERSAL TWIN NEEDLE



- **System 130/705 H ZWI NE 1,6**
Needle distance 1.6 mm, needle sizes NM 70 and NM 80
- **System 130/705 H ZWI NE 2,0**
Needle distance 2.0 mm, needle size NM 80
- **System 130/705 H ZWI NE 2,5**
Needle distance 2.5 mm, needle size NM 80
- **System 130/705 H ZWI NE 3,0**
Needle distance 3.0 mm, needle size NM 90
- **System 130/705 H ZWI NE 4,0**
Needle distance 4.0 mm, needle sizes NM 80 to NM 100

UNIVERSAL TWIN NEEDLE



- **With very widely spaced needles:**
- **System 130/705 H ZWI BR NE 6,0**
Needle distance 6.0 mm, needle size NM 100
- **System 130/705 H ZWI BR NE 8,0**
Needle distance 8.0 mm, needle size NM 100

STRETCH TWIN NEEDLE



- **System 130/705 H-S ZWI NE 2,5**
Needle distance 2.5 mm, needle size NM 75
- **System 130/705 H-S ZWI NE 4,0**
Needle distance 4.0 mm, needle size NM 75

JEANS TWIN NEEDLE



- **System 130/705 H-J ZWI NE 4,0**
Needle distance 4.0 mm, needle size NM 100

METALLIC TWIN NEEDLE



- **System 130 MET ZWI NE 2,5**
Needle distance 2.5 mm, needle size NM 80
- **System 130 MET ZWI NE 3,0**
Needle distance 3.0 mm, needle size NM 90

EMBROIDERY TWIN NEEDLE



- **System 130/705 H-E ZWI NE 2,0**
Needle distance 2.0 mm, needle size NM 75
- **System 130/705 H-E ZWI NE 3,0**
Needle distance 3.0 mm, needle size NM 75

DOUBLE HEMSTITCH NEEDLE



- **System 130/705 H ZWIHO**
Needle distance 2.5 mm, needle size NM 100
1 **UNIVERSAL NEEDLE** together with 1 **HEMSTITCH NEEDLE**

UNIVERSAL TRIPLE NEEDLE

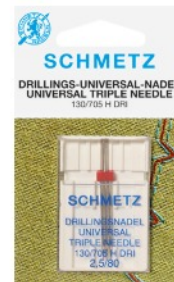

- **System 130/705 H DRI NE 2,5**
Needle distance 2.5 mm, needle size NM 80
- **System 130/705 H DRI NE 3,0**
Needle distance 3.0 mm, needle size NM 80

SCHMETZ



FERD. SCHMETZ GMBH, Bicherouxstraße 53 - 59,
52134 Herzogenrath (Germany)
Tel. +49 (0) 2406 - 85 0, Fax +49 (0) 2406 - 85 222
www.schmetz.com, info@schmetz.com