



Tape measures and more ...

“Made in Germany” makes the difference





Inhaltsverzeichnis 





















Seite	6 - 31	Maßbänder	
	32 - 55	Rollmaßbänder	
	56 - 65	Gesundheit	
	66 - 73	Markierstifte	
	74 - 79	Nahtrenner	
	80 - 85	Nähelfer	
	86 - 87	Divers	







Table of Contents 

page	6 - 31	Tape measures	
	32 - 55	Roller tape measures	
	56 - 65	Health	
	66 - 73	Marking pens	
	74 - 79	Seam rippers	
	80 - 85	Sewing accessories	
	86 - 87	Various	

Contenu 

page	6 - 31	Mètres ruban	
	32 - 55	Mètres automatiques	
	56 - 65	Santé	
	66 - 73	Crayons à marquer	
	74 - 79	Découseurs	
	80 - 85	Accessoires de couture	
	86 - 87	Divers	

Indice de contenido 

página	6 - 31	Cintas métricas	
	32 - 55	Cintas métricas enrollables	
	56 - 65	Salud	
	66 - 73	Lápices marcadores	
	74 - 79	Deshilador	
	80 - 85	Accesorios de costura	
	86 - 87	Varios	

hoechstmass – wenn Qualität zählt

Das Unternehmen wurde 1895 gegründet und blickt auf eine über 120-jährige Erfolgsgeschichte zurück. hoechstmass gehört zu den weltweit führenden Herstellern von flexiblen und qualitativ hochwertigen Maßbändern. In unserem Werk in Sulzbach am Taunus produzieren wir ein vielseitiges Produktsortiment, von klassischen Schneidermaßbändern über automatische Rollmaßbänder bis hin zum elektronischen Maßband zur digitalen Datenverarbeitung. Darüber hinaus umfasst unsere Produktpalette auch ein verkaufsstarkes Sortiment an Markierstiften, Nahttrennern und Nähhilfen.

Werbeartikel von Qualität

Neben den klassischen Kurzwaren vertreiben wir unsere Produkte auch als Werbeträger für national und international agierende Unternehmen, die in ganz unterschiedlichen Branchen ansässig sind. Ein qualitativ hochwertiges Maßband von hoechstmass, bedruckt mit Ihrem Logo, ergibt ein langlebiges Werbegeschenk an Ihre Kunden, hergestellt in Deutschland. Inwieweit das jeweilige Produkt personalisiert werden soll, können Sie selbst entscheiden. Neben einer breiten Palette an Artikeln und Farben, gibt es verschiedene Druckbereiche, die Platz für Ihre Marke bieten.

Sonderanfertigungen und Service sind unsere besonderen Stärken

Unser Portfolio hat vielseitige Einsatzgebiete und doch gibt es Bereiche, für welche ein individuell gestaltetes Produkt unabdingbar ist. Jährlich setzt hoechstmass eine große Menge an Sonderanfertigungen um, die in enger Zusammenarbeit mit dem Kunden erarbeitet werden und welche die Qualitätsanforderungen jedes einzelnen erfüllen.

Sorgfalt in Beschaffung und Verarbeitung

Unsere Produkte werden überall auf der Welt eingesetzt und haben sich millionenfach bewährt. Die Verwendung von hochwertigen Rohstoffen und Materialien, sowie permanente Prüf- und Kontrollverfahren gewährleisten dauerhafte Funktion und Qualität. Durch ständige Weiterentwicklungen und Kompetenz entstehen innovative, marktorientierte Produkte, die durch Patente international abgesichert sind.

Made in Germany heißt für uns: Qualität, Genauigkeit und Zuverlässigkeit!

hoechstmass - when quality matters

The company was founded in 1895 and looks back on a more than 120-year success story. hoechstmass is one of the world's leading manufacturers of flexible and high-quality tape measures. In our factory in Sulzbach/Taunus we produce a wide range of products, from classic tailor tapes to automatic roller tapes and electronic measuring tape for digital data processing. In addition, our product range also includes a sales boosting range of marking pens, seam rippers and sewing aids.

Promotional products of quality

In addition to the classic haberdashery, we also sell our products as an advertising medium for nationally and internationally operating companies that are based in very different industries. A high-quality tape measure from hoechstmass printed with your logo results in a durable giveaway to your customers, manufactured in Germany. To what extent the respective product should be personalized, you can decide for yourself. In addition to a wide range of articles and colours there are various print areas that provide space for your brand.

Special productions and service are our special strengths

Our portfolio has a wide range of applications and yet there are areas for which an individually designed product is indispensable. Every year, hoechstmass implements a large number of custom-made products, which are developed in close cooperation with the customer and which meet the quality requirements of each individual.

Care in procurement and processing

Our products are used all over the world and have proven themselves millions of times. The use of high quality raw materials and materials, as well as permanent testing and control procedures ensure the long-lasting function and quality. Constant further development and competence result in innovative, market-oriented products, which are internationally protected by patents.

Made in Germany means for us: quality, precision and responsibility!

hoechstmass - quand la qualité compte

La société a été fondée en 1895 et peut se prévaloir d'un historique de plus de 120 ans. hoechstmass est l'un des principaux fabricants mondiaux de mètres ruban souples et de haute qualité. Dans notre usine de Sulzbach au Taunus, nous fabriquons une gamme de produits variée, allant des rubans de couture classiques aux rubans à rouler automatiques en passant par les rubans à mesurer électroniques pour le traitement numérique des données. En outre, notre gamme de produits comprend également une gamme très vendue de crayons craie, découseurs et aides à la couture.

Produits promotionnels de qualité

En plus de la mercerie classique, nous vendons également nos produits en tant que support publicitaire pour des sociétés opérant au niveau national et international et situées dans des industries très différentes. Un mètre ruban de haute qualité de Hoechstmass, portant votre logo, constitue un cadeau durable pour vos clients, fabriqué en Allemagne. Dans quelle mesure le produit respectif doit être personnalisé, vous le décidez vous-mêmes. En plus d'une large gamme d'articles et de couleurs, il existe différentes zones d'impression offrant un espace pour votre marque.

Les produits et services sur mesure sont nos atouts particuliers

Notre portefeuille a une variété d'utilisations et pourtant, il existe des domaines pour lesquels un produit conçu individuellement est indispensable. hoechstmass met en œuvre chaque année un grand nombre de produits sur mesure, développés en étroite collaboration avec le client et répondant aux exigences de qualité de chaque personne.

Soins dans l'approvisionnement et le traitement

Nos produits sont utilisés partout dans le monde et ont fait leurs preuves des millions de fois. L'utilisation de matières premières et de matériaux de haute qualité, ainsi que des procédures de test et de contrôle permanents, garantissent une fonction et une qualité durables. Grâce à un développement et à des compétences constants, des produits innovants, orientés vers le marché et protégés au niveau international par des brevets sont créés.

Made in Germany signifie pour nous: qualité, précision et fiabilité!

hoechstmass – cuando la calidad es lo que importa

hoechstmass es uno de los principales fabricantes mundialmente de cintas métricas flexibles y de una calidad extraordinaria. La compañía fue fundada en 1895 y puede presumir de un historial exitoso con más de 120 años de experiencia. En nuestra empresa en Sulzbach / Taunus, producimos una amplia gama de productos, desde cintas métricas clásicas hasta cintas métricas enrollables y cintas métricas electrónicas para el procesamiento de datos digitales. Se pueden incluir los productos de lápices marcadores, deshiladores y otros accesorios de costura.

Productos para promoción, de calidad

Además de los clásicos productos de mercería, se utilizan nuestros productos como material publicitario para empresas nacionales e internacionales de diferentes sectores industriales. Una cinta métrica de una selecta calidad con su logo estampado, es un regalo duradero e inolvidable, fabricado en Alemania. Usted puede decidir en que medida el producto respectivo, se personaliza. Además de una amplia gama de artículos y colores, hay varias posibilidades de estampar su marca en diferentes partes con el fin de promoción.

Nuestros productos y servicios personalizados son nuestros puntos fuertes

Nuestra cartera tiene versátiles sectores de aplicación. Sin embargo hay sectores donde un producto de diseño individual es indispensable. Cada año hoechstmass produce una gran cantidad de productos a medida que han sido desarrollados en una estrecha colaboración con nuestros clientes, según los encargos y que además cumplen todos los requisitos de calidad.

Con el esmero debido en procuramiento y procesamiento

Nuestros productos se utilizan mundialmente y millones de veces, por eso el uso de materias primas de alta calidad, como comprobamiento y el control permanente de nuestros productos, garantizan la funcionalidad y calidad a largo plazo. Por nuestro constante desarrollo e innovación, podemos presentar productos innovadores y los más novedosos que además son protegidos por patentes internacionalmente.

Fabricado en Alemania significa para nosotros : calidad, precisión y fiabilidad



- 

Qualitätsmaßband für den alltäglichen Gebrauch. Eine Seite weiß, andere Seite gelb, verfügbar in 3 verschiedenen Bandbreiten. Das 10 mm breite Maßband ist auch im Bonbonpapier erhältlich, ideal als kleines Kundenpräsent. Wahlweise im Bonbonglas als Aufsteller im Laden oder auf Events.
- 

Quality tape measure for everyday use. One side white, the other side yellow, available in three different tape widths. The 10 mm wide tape measure is also available in candy wrapper, ideal as a small present for your customers. Optionally in candy jar as display in the shop or on events as give-away.
- 

Mètre ruban de qualité pour un usage quotidien. Un côté blanc, l'autre côté jaune, disponible en trois largeurs différents. Le mètre ruban de 10 mm de largeur est également disponible en emballage bonbon, petit cadeau idéal pour les clients. En option dans un bocal à bonbons.
- 

Cinta métrica de calidad para el uso diario. Una cara del cinta es blanca, la otra amarilla. Es disponible en tres diferentes anchuras. La cinta métrica de 10mm de ancho también es disponible en envoltorios de caramelo, que sea ideal como regalo publicitario. Opcionalmente se puede prentar en un tarro de caramelos, encima del despacho de venta o eventos, ferias, etc.

Length **150 cm / 60 inch**

Width **10 mm**
15 mm
18.5 mm

Scale



cm/cm



cm/inch



cm+div/cm+div





analog/analog

	Verpackung Packaging	Beschreibung Description	VPE Unit	Umkarton Export unit	Skala Scale	Artikel Reference
10 mm						
	EL	with elastic bulk packed	40	400	cm/cm cm/inch	31101 31201
	DP 100	candy jar with 100 pcs. candy wrapped assorted colours	100	14 sets	cm/cm cm/inch	31142 31242
15 mm						
	GL	laid in box	10	800	cm/cm cm/inch analog/analog	35102 35202 35402
	CL	clip	10	560	cm/cm cm/inch analog/analog	35104 35204 35404
	DS	transparent plastic box	10	100	cm/cm cm/inch analog/analog	35105 35205 35405
18.5 mm						
	GL	laid in box	10	800	cm/cm cm/inch cm+div/cm+div	39102 39202 39302
	CL	clip	10	560	cm/cm cm/inch cm+div/cm+div	39104 39204 39304
	SB	self service blister-card	5	120	cm/cm cm/inch cm+div/cm+div	39106 39206 39306



- 

Meistverkauftes Allroundmaßband in bewährter Qualität mit farbiger Dezimeter-Einteilung. Eine Seite mit wechselndem Farbfond alle 10 cm, wodurch das Ablesen des richtigen Messwertes instinktiv vereinfacht wird. Andere Seite durchgehend gelbes Band.
- 

Best-selling all-round tape measure in proven quality with colored decimeter graduation. One side with changing color fund every 10 cm, which instinctively simplifies the reading of the correct measurement. Other side in yellow throughout.
- 

Le ruban à mesurer polyvalent le plus vendu, d'une qualité éprouvée avec une graduation de décimètre colorée. Une face avec le fond de couleur changeant tous les 10 cm, ce qui simplifie instinctivement la lecture de la valeur correcte. L'autre face du ruban en jaune.
- 

La cinta métrica más vendida de una calidad probada. La cinta tiene la distribución de decímetros en diferentes colores. Una cara tiene cada 10 cm un otro color así se facilita la lectura correcta al medir. El otro lado de cara es amarilla.

Length **150 cm / 60 inch**

Width **18.5 mm**

Scale

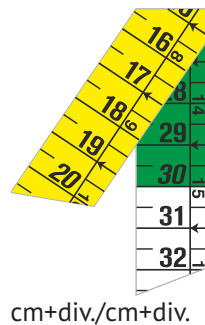
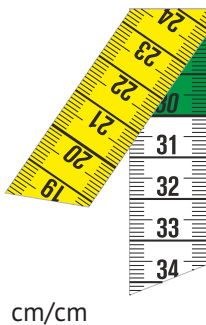

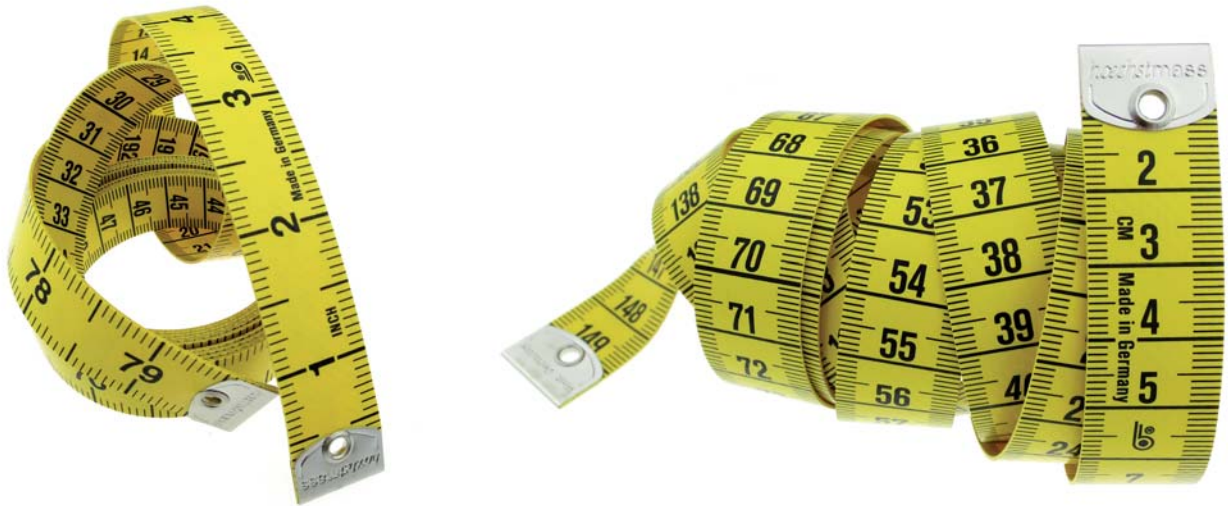

	Verpackung Packaging	Beschreibung Description	VPE Unit	Umkarton Export unit	Skala Scale	Artikel Reference
	GL	laid in box	10	800	cm/cm cm/inch cm+div/cm+div	59102 59202 59302
	CL	clip	10	560	cm/cm cm/inch cm+div/cm+div	59104 59204 59304
	DS	transparent plastic box	10	100	cm/cm cm/inch cm+div/cm+div	59105 59205 59305
	CFP	reinforced plastic end (10 cm)	10	380	cm/cm cm/inch cm+div/cm+div	59107 59207 59307
	SB	self service blister-card	5	120	cm/cm cm/inch	59106 59206
	DK	press-button	10	560	cm/cm cm/inch	59108 59208
	DK SB	press-button self service blister-card	5	120	cm/cm cm/inch	59109 59209



- 

Professionelles Schneidermaßband mit einer dickeren Materialstärke als gewöhnlich. Erhältlich in 150 und 200 cm Länge sowie in diversen Sonderausführungen für spezielle Einsätze im Schneiderhandwerk. Beidseitig gelbes Maßband mit geösten Metallbeschlägen.
- 

Professional tape measure with a thicker material than usual. Available in lengths of 150 and 200 cm as well as in various special versions for special applications in tailoring. Yellow tape measure with metal eye tips on both sides.
- 

Mètre ruban professionnel avec un matériau plus épais que d'habitude. Disponible dans en longueurs de 150 et 200 cm ainsi que dans différents modèles spéciaux pour des applications spéciales dans la confection. Mètre ruban jaune avec fins métalliques œilletés des deux bouts.
- 

Cinta métrica profesional para el sastre con un material más grueso de lo habitual. Disponible en longitudes de 150 y 200 cm, así como en varios diseños especiales para aplicaciones especiales en sastrería.

Length **150 cm / 60 inch**
200 cm / 80 inch

Width **18.5 mm**

Scale



cm/cm





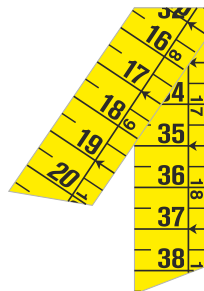

cm/inch

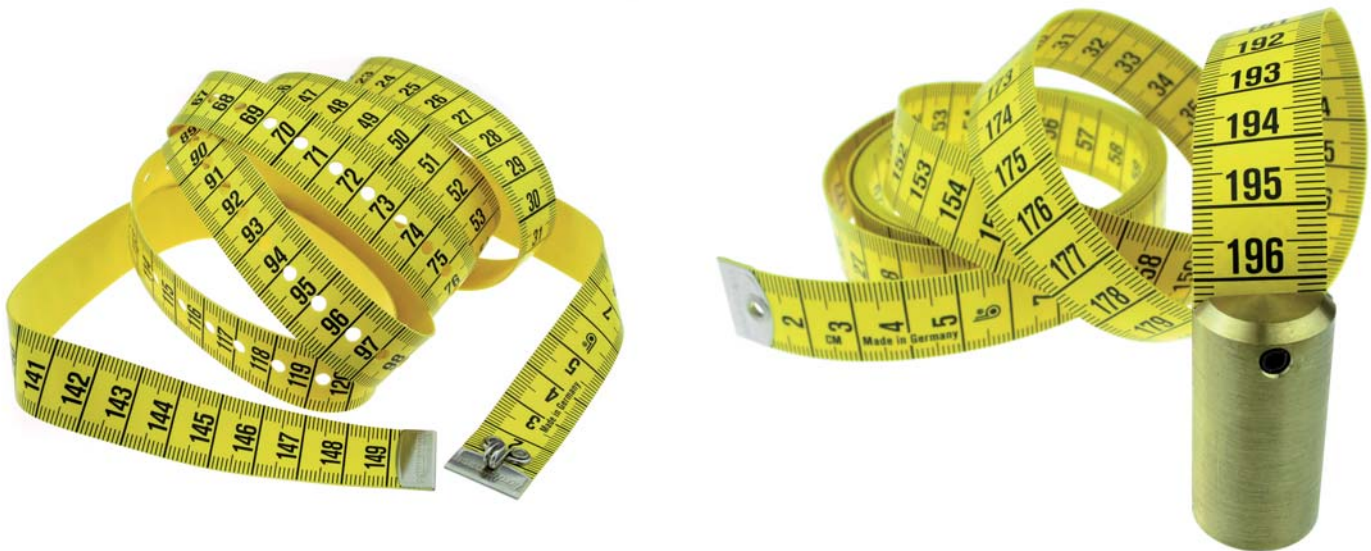

cm+div/cm+div

	Verpackung Packaging	Beschreibung Description	VPE Unit	Umkarton Export unit	Skala Scale	Artikel Reference
150 cm (60")						
	GL	laid in box	10	380	cm/cm cm/inch cm+div/cm+div	79102 79202 79302
	CL	clip	10	380	cm/cm cm/inch cm+div/cm+div	79104 79204 79304
	SB	self service blister-card	5	120	cm/cm cm/inch cm+div/cm+div	79106 79206 79306
200 cm (80")						
	GL	laid in box	10	380	cm/cm cm/inch	72102 72202
	DS	transparent plastic box	10	100	cm/cm cm/inch	72105 72205



- 
 Profi-Maßbänder für spezielle Herausforderungen: als Schritt-Achsel-Maß mit 10 cm langer Messingversteifung, Taillenmaß mit Haken und Löchern von cm 60-120 für den Bauchumfang und als Lotmaß mit Messinggewicht.
- 
 Professional tape measures for special challenges: as a crotch-armpit tape measure with 4 inch brass end, waist tape measure with hook and holes of cm 60-120 for the belly circumference and as a tape measure for the lot with brass weight.
- 
 Mètre ruban professionnel pour les enjeux particuliers, par exemple avec un bout en laiton pour mesurer à l'aisselle et l'entrejambe, et afin de prendre les mesures du tour de taille il y a un crochet et des trous au cm 60 jusqu'à 120 et finalement cet article est disponible avec un perpendiculaire.
- 
 Cinta métrica profesional para medidas especiales. Medida de axilas, con un resfuerzo de latón de 10cm. Medida de cintura, se fija la medida a través de un gancho y orificios de los 60-120cm. Como perpendicular con un contrapeso de latón.

Length **150 cm / 60 inch**
200 cm / 80 inch

Width **18.5 mm**





Scale



cm/cm





cm/inch

	Verpackung Packaging	Beschreibung Description	VPE Unit	Umkarton Export unit	Skala Scale	Artikel Reference
150 cm (60")						
	4 BR	4 inch (10cm) brass end clip	10	380	cm/cm cm/inch	79107 79207
	4 BR SB	4 inch (10cm) brass end self service blister-card	5	60	cm/cm cm/inch	79112 79212
	HK	with holes and hook clip	10	380	cm	79113
200 cm (80")						
	DS	transparent plastic box	10	100	cm/cm cm/inch	72105/L 72205/L



- 

Glasfaserverstärktes Maßband mit versiegelten Kanten und geösten Metallbeschlägen. Lieferbar in 2 Bandbreiten mit 15 mm oder 18,5 mm. Das 15 mm breite Band kann als Schritt-Achsel-Maß mit Messingversteifung bestellt werden.
- 

Glass fiber reinforced tape measure with sealed edges and metal tips with eyelet. Available in 2 tape widths with 15 mm or 18.5 mm. The 15 mm wide tape can be ordered as a crotch armpit tape measure with 3 inch brass reinforcement.
- 

Mètre ruban renforcé de fibres de verre avec bords scellés, bouts métalliques œilletés. Disponible en 2 largeurs de ruban: 15 mm et 18,5 mm. Le mètre ruban de 15 mm de largeur est disponible avec un bout en laiton pour mesurer à l'aisselle et l'entrejambe.
- 

Cinta métrica de plástico reforzado por fibra de vidrio con las filar selladas y con ojales metálicos. Disponible en dos anchuras, con 15mm y 18,5mm. Puede ser encargada la cinta de 15mm de anchura para las medidas de entrepierna-axial con rigizadores de latón.

Length **150 cm / 60 inch**

Width **15 mm
18.5 mm**

Scale



cm/cm

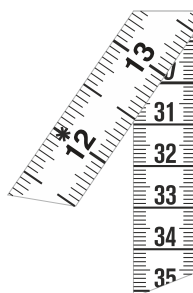

cm/inch





analog/analog

	Verpackung Packaging	Beschreibung Description	VPE Unit	Umkarton Export unit	Skala Scale	Artikel Reference
15 mm						
	CL	clip	10	380	cm/cm cm/inch analog/analog	65104 65204 65404
	3BR	3 inch (7,5 cm) brass end clip	10	380	cm/cm cm/inch analog/analog	65107 65207 65407
	3BR SB	3 inch (7,5 cm) brass end self service blister-card	5	60	cm/cm cm/inch analog/analog	65112 65212 65412
18.5 mm						
	GL	laid in box	10	380	cm/cm cm/inch	69102 69202
	DS	transparent plastic box	10	100	cm/cm cm/inch	69105 69205
	SB	self service blister-card	5	120	cm/cm cm/inch	69106 69206



- 

CEFES® CONTROL, das zertifizierte Maßband mit EWG -Bauartzulassung. Präzisionsmaßband hergestellt nach Klasse II der europäischen Eichvorschrift. Längentoleranz über die gesamte Bandlänge: max. +/-0,7 mm bei einer Temperatur von 20 Grad Celsius und einer Zugkraft von 10N.
- 

CEFES® CONTROL, the certified tape measure with EEC type license. Precision tape measure manufactured according to Category II of the State Office of Legal Metrology. Length tolerance along the entire tape length: max. +/-0.7 mm at a temperature of 20°C and tension of 10N.
- 

CEFES® CONTROL, le mètre pour couturier, conforme aux normes CEE. Mètre ruban de haute précision selon la classe II et les directives européennes en matière de poids et mesures. Tolérance de longueur sur la longueur totale du ruban: max +/-0,7 mm à une température de 20°C et une force de traction de 10N.
- 

CEFES® CONTROL, cinta métrica de costura, certificada, fabricada según el modelo matriculado por las normas de CEE. Esta cinta métrica de alta precisión, corresponde a la clase II, según el calibrador del la Unión Europea. Tolerancia de logitud hasta +/-0,7mm, en el margen de una temperatur de 20C y con una tensión de 10N.

Length **150 cm / 60 inch**

Width **18.5 mm**

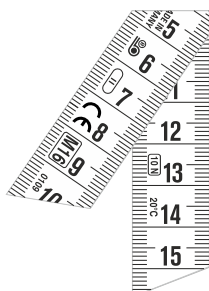

Scale







cm/cm



cm/inch

	Verpackung Packaging	Beschreibung Description	VPE Unit	Umkarton Export unit	Skala Scale	Artikel Reference
	DS	transparent plastic-box	10	100	cm/cm cm/inch	63105 63205
	SB	self service card with transparent plastic-box	5	60	cm/cm cm/inch	63106 63206



- 
 150 cm langes Schneidermaßband in abwechslungsreichen und angesagten Farben pink, grün und blau mit moderner Skala in weiß. Bei beidseitiger cm-Einteilung ist die Skala gleichlaufend. Bewährte Poly-Fiber Qualität, beide Enden mit Metallbeschlag.
- 
 150 cm long tailoring tape measure in varied and trendy colors pink, green and blue with modern scale in white. If cm is divided on both sides, the scale runs in the same direction. Proven poly-fiber quality, both ends with metal tips.
- 
 Mètre ruban de 150 cm de longueur dans des couleurs variées et à la mode, rose vif, vert et bleu, avec une échelle de graduation moderne en blanc. Si le mètre ruban est imprimé cm/cm, la graduation se lit de la gauche à la droite sur les deux faces du ruban. Qualité éprouvée en poly-fibre, aux deux extrémités avec fins métalliques.
- 
 Cinta métrica de 150 cm de longitud en colores de moda rosa, verde o azul y con una distribución moderna en color blanco. La escala se queda paralela si lleva la distribución en CM de doble cara. Calidad de polifibra, ambos extremos con remates de latón.

Length **150 cm / 60 inch**

Width **18.5 mm**



Scale







cm/cm



cm/inch

	Verpackung Packaging	Beschreibung Description	VPE Unit	Umkarton Export unit	Skala Scale	Artikel Reference
	CL	clip assorted colours	10	560	cm/cm cm/inch	61104 61204
	SB	self service blister-card assorted colours	5	120	cm/cm cm/inch	61106 61206



- 
 Miedermaßband zur Ermittlung der BH-Größe. Zuerst wird mit der cm-Skala die BH-Grundgröße ermittelt, im Anschluss mit der Cupsize-Seite die individuell geeignete Körbchengröße. Maßband in sortierten Farben pink, grün und blau.
- 
 Corset tape measure to determine the bra size. First, the cm-scale is used to determine the basic size of the bra, followed by the cupsize side for the individually suitable cup size. Tape measure in assorted colors pink, green and blue.
- 
 Mètre ruban pour mesurer le tour de poitrine afin de déterminer la taille du soutien-gorge. En utilisant l'échelle de cm on détermine la taille de base du soutien-gorge, et ensuite en utilisant l'autre côté du ruban on trouve la bonne taille du bonnet. Ce produit est disponible en rose, vert ou bleu.
- 
 Cinta métrica para averiguar el tamaño de sujetador. Primero se utiliza la escala de CM para determinar el tamaño de la cinta de sujetador, luego se usa la cara del cupsize para conseguir el tamaño correcto de la copa. Esta cinta es disponible en los colores rosa, verde y azul.



Length **150 cm**

Width **18.5 mm**

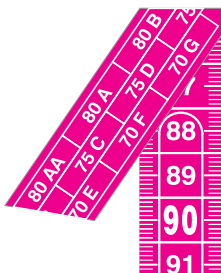



Scale



cm/Cup Sizes

	Verpackung Packaging	Beschreibung Description	VPE Unit	Umkarton Export unit	Skala Scale	Artikel Reference
	DS	transparent box assorted colours	10	100	cm+ Bra sizes/ Cup sizes	59105-BRA
	SB	self-service blister card assorted colours	5	60	cm+ Bra sizes/ Cup sizes	59106-BRA



-  Maßband zum Messen von Schuhleisten, für den professionellen Gebrauch. Eine Seite cm-mm oder analog-Skala (Kombination cm+inch), andere Seite mit englischen Größen und französischem Stich. Im Maßband ist am Ende eine Metallöse eingearbeitet.
-  Tape measure for measuring shoe, for professional use. One side cm-mm or analogue scale (combination cm + inch), other side with English sizes and French stich. The tape measure has a metal eyelet at the end.
-  Mètre cordonnier pour mesurer la forme. Application professionnelle. Un coté avec la graduation cm-mm, alternativement l'échelle analogique (une combinaison de cm et inch sur la même face) et l'autre côté avec des tailles anglaises et les tailles francaises. A la fin du ruban un œillet métallique.
-  Cinta métrica para medidas profesionales de horma de zapatos. Una parte es en cm-mm o escala analógica (cm+inch) y la otra cara con tamaños ingleses y grabado francés. La cinta métrica tiene un ojal de metálico al final.

Length **72 cm**
scale from 0-60 cm / 24 inch

Width **12 mm**

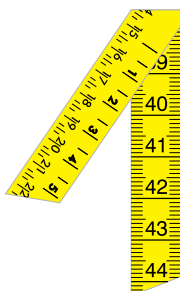

Scale





cm/Engl. size



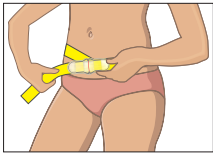

analog/Engl. size

	Verpackung Packaging	Beschreibung Description	VPE Unit	Umkarton Export unit	Skala Scale	Artikel Reference
	GL	laid in box	12	960	cm/Engl. Size + Stich	71102
					analog/Engl. Size + Stich	71402
	EL	rolled with elastic	10	560	cm/Engl. Size + Stich	71103
					analog/Engl. Size + Stich	71403



- 

Umfangmaß zum einfachen Ermitteln von Körpermaßen, ideal für die Selbstanwendung. Maßband um den Körper legen, Messschieber schließen und Maßband stramm ziehen. Um das Ergebnis abzulesen wird der Verschluss einfach geöffnet, der patentierte Messschieber bleibt auf dem Messwert stehen.
- 

Circumference tape measure for easy determination of body measurements, ideal for self-application. Lay the tape measure around the body, close the slider with the press-button and pull the measuring tape tight. To read the result, the closure is simply opened, the patented slider stays on the measured value.
- 

Mètre ruban pour prendre facilement les mesures corporelles. Idéal pour l'auto-application. Poser le mètre ruban autour du corps, fermer le curseur à l'aide du bouton-poussoir et tirer au bout. Pour lire le résultat ouvrir le bouton-poussoir, le curseur brevetée reste sur la mesure prise.
- 

Cinta métrica para medir por ejemplo la cintura u otras proporciones corporales, ideal para la auto-aplicación. Se coloca la cinta por ejemplo sobre alrededor de la cintura, se aprietan los cierres y deslizando el vernier, hasta que ajustado. Ahora se puede ver en el vernier la medida exacta. Al abrir la cinta, queda la medida en el vernier, que ha sido patentado, visible.

Length **150 cm / 60 inch**

Width **18.5 mm**



Scale



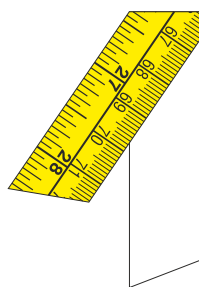

cm



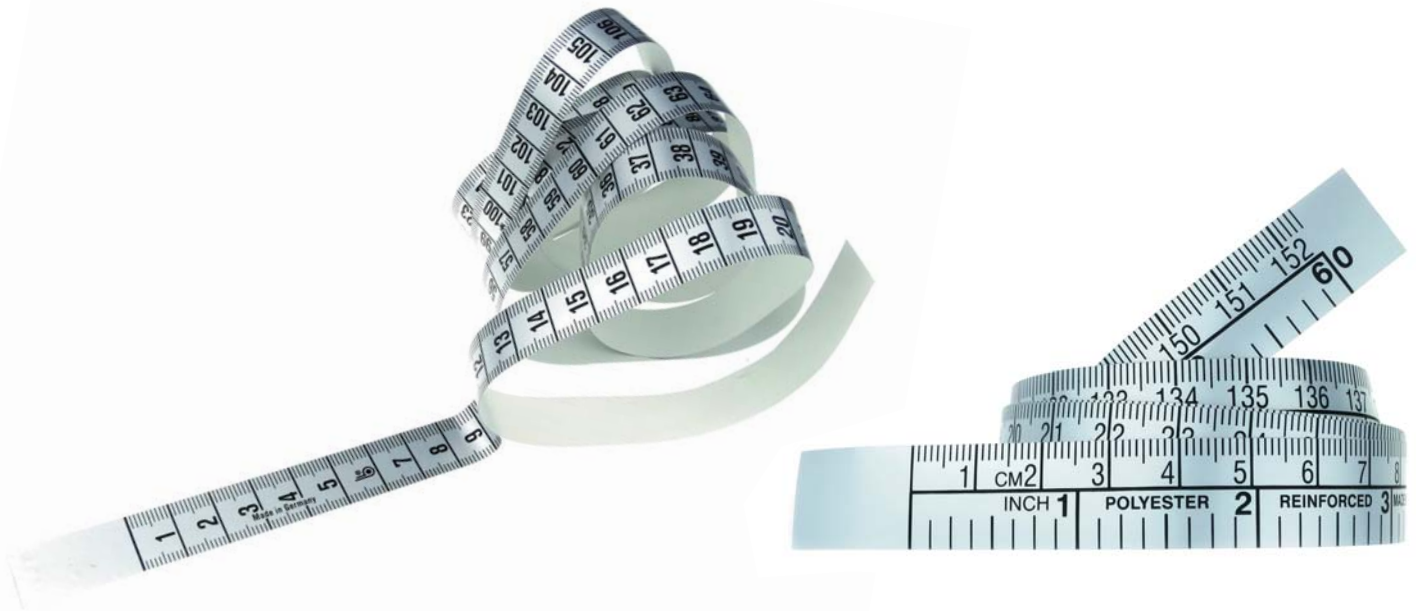

analog

	Verpackung Packaging	Beschreibung Description	VPE Unit	Umkarton Export unit	Skala Scale	Artikel Reference
	EL	rolled with elastic	10	200	cm analog	53103 53403
	SB	self service blister-card	5	60	cm analog	53106 53406
	SB DP	self service blister-card in Display Box	15	135	cm analog	53142 53442



- 

Praktisches Maßband zum Aufkleben, zum Beispiel am Schneidetisch. Schwarze cm-mm oder analog-Skala (Kombination cm+inch) auf silberner Selbstklebefolie.
- 

Practical tape measure for gluing, for example on the cutting table. Black cm-mm or analogue scale (combination cm + inch) on silver self-adhesive foil.
- 

Mètre ruban autocollant, pratique pour le collage, par exemple sur la table de découpe. Echelle noire en cm ou analogique (combinaison cm + inch) sur un film autocollant argenté.
- 



Cinta métrica muy práctica pegable, por ejemplo sobre una mesa de corte y confección. Scala cm-mm en negro o scala analògica (combinación cm+inch) en una cinta.

Length **150 cm / 60 inch**



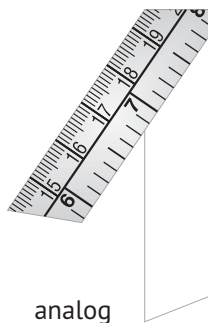

Width **15 mm**

Scale



	Verpackung Packaging	Beschreibung Description	VPE Unit	Umkarton Export unit	Skala Scale	Artikel Reference
	GL	laid in box	25	950	cm analog	11102 11402
	SB	2 pieces on self service blister-card	5	60	cm analog	11106 11406
	SB DP	2 pieces on self service blister-card in Display Box	15	135	cm analog	11142 11442



-  Maßband für Menschen mit Sehbeeinträchtigung oder Erblindung. Eine Seite mit fühlbar, erhabenen Braille-Punkten, andere Seite mit gedruckter cm-mm Skala von 0-150 cm. Hochwertiges Maßband, beidseitig weiß und mit Metallbeschlägen an den Enden.
-  Tape measure for people with visual impairment or blindness. One side with palpable, raised braille dots, the other side with printed cm-mm scale from 0-150 cm. High quality tape measure, white on both sides and with metal tips on the ends.
-  Mètre ruban de haute qualité pour les aveugles. Une face avec les chiffres en braille, l'autre face avec l'échelle cm-mm de 0 à 150 cm. Ruban blanc sur les deux faces, fin métallique aux deux bouts.
-  Cinta métrica para personas con discapacidad visual o ceguera. Un lado con puntos braille palpables, el otro lado con escala de cm-mm de 0-150 cm. Cinta métrica de una calidad, blanca en ambos lados y con remates de latón.

Length **150 cm**

Width **18.5 mm**

Scale

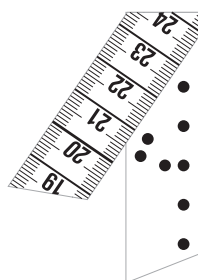



cm/braille

	Verpackung Packaging	Beschreibung Description	VPE Unit	Umkarton Export unit	Skala Scale	Artikel Reference
	DS	transparent plastic box	10	100	cm/braille	59905-BL



- 

Maßband und Lanyard in einem: praktisches Umhängeband mit ca. 100 cm Länge und Karabiner zur Befestigung von Messe- oder Firmenausweisen, Schlüsseln oder anderen Dingen. Durch Öffnen des Druckknopfes lassen sich anhand der maßhaltigen Skala Messungen durchführen. Erhältlich in schwarz, weiß, blau, rot und gelb.
- 

Tape measure and lanyard in one: practical neck strap with a length of approx. 100 cm and a carabiner for attaching trade fair pass or company IDs, keys or other things. By opening the push button, measurements can be taken on the basis of the dimensional scale. Available in black, white, blue, red and yellow and with cm or inch scale.
- 

À la fois mètre ruban et lanyard: lanière tour de cou pratique, d'une longueur d'environ 100 cm avec mousqueton pour y attacher par exemple un ticket d'entrée, des clés etc. Disponible dans les coloris noir, blanc, bleu, rouge et jaune et avec une échelle de cm-mm ou en inch.
- 

Cinta métrica en forma de una práctica correa para colgar al cuello, tiene un mosquetón donde se puede fijar la tarjeta de identificación de empresa o de una feria, llaves o otras cosas. Tiene una longitud aproximadamente de 100cm. Al abrir el broche de presión, se puede usar como cinta para tomar medidas. Esta cinta es disponible en los colores negro, blanco, azul, rojo y amarillo.

Length **105 cm**

Width **18.5 mm**

Scale



cm







inch

	Verpackung Packaging	Beschreibung Description	VPE Unit	Umkarton Export unit	Skala Scale	Artikel Reference
	CL	clip assorted colours	10	560	cm inch	33103 33203
	TB	transparent box assorted colours	3	36	cm inch	33144 33244

Farben / Colours









-  Kleines Rollmaßband im Taschenformat mit Schlüsselkette, ideal als Schlüsselanhänger. 150 cm langes Maßband im 4 cm großen Gehäuse in 5 klassischen Farben. Schlagfestes ABS-Gehäuse mit patentierter Stop & Go Aufroll-Automatik, zuverlässig und bewährt.
-  Small pocket size tape measure with key chain, ideal as a pendant to the key. 150 cm long tape measure in 4 cm case in 5 classic colors. Impact-resistant ABS case with patented Stop & Go automatic retractable, reliable and proven.
-  Mètre enrouleur automatique de 150 cm de longueur dans un boîtier plastique de 4 cm de diamètre, avec une chaîne porte-clés métallique. Disponible en 5 coloris classiques. Boîtier en plastique ABS résistant aux chocs, enrouleur automatique breveté Stop & Go, fiable et éprouvé.
-  Cintas métricas enrollable pequeña de bolsillo con llavero, ideal como colgante para la llave. Cinta métrica de 150 cm de largo en estuche de 4 cm en 5 colores clásicos. Carcasa de ABS resistente a los impactos con sistema patentado Stop & Go, retráctil, confiable y comprobado.

Length **150 cm / 60 inch**

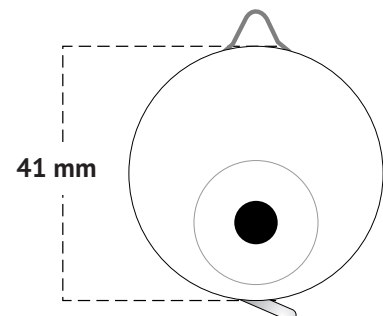
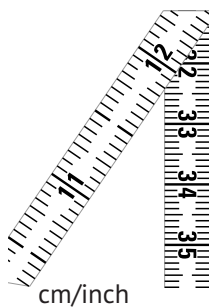
Width **8 mm**

Scale







	Verpackung Packaging	Beschreibung Description	VPE Unit	Umkarton Export unit	Skala Scale	Artikel Reference
	bulk	box assorted colours	10	560	cm/inch	84203
	SB	self service blister-card assorted colours	5	120	cm/inch	84206
	DP 14	Display with 14 pcs., assorted colours	1 set	10 sets	cm/inch	84242/14
	DP 10	Display with 10 pcs., assorted colours	1 set	40 sets	cm/inch	84242/10



Farben / Colours

white yellow red blue black





-  Rollmaßband pillow in Kissenform mit matter Oberfläche in den Trendfarben rosa, hellblau, petrol, aubergine, koralle und grün. Schlagfestes ABS-Gehäuse mit patentierter Stop & Go Aufroll-Automatik, zuverlässig und bewährt. Optional mit Karabiner oder Lanyard erhältlich.
-  Small roller tape measure in the form of a pillow with matt surface in the trend colors rose, light blue, petrol, aubergine, coral and green. Impact-resistant ABS case with patented Stop & Go automatic retractor, reliable and proven. Optionally available with carabiner or lanyard.
-  Petit mètre enrouleur automatique en forme d'un coussin. La surface mate dans les coloris à la mode rose, bleu clair, bleu pétrole, aubergine, corail et vert. Boîtier en plastique ABS résistant aux chocs, enrouleur automatique breveté Stop & Go, fiable et éprouvé. Disponible en option avec un mousqueton ou un lanyard.
-  Cinta métrica enrollable con la carcasa en forma de cojin, con una superficie mate en colores de las tendencia nuevas, como rosa, azul claro, petrol, morado oscuro, cora y verde. La carcasa es de ABS y así resistentes a golpes, además tiene un retractor automatic stop & go patentado, fiable y acreditado. Opcionalmente con cinta colgable o con gancho de mosquetón.

Length **150 cm / 60 inch**

Width **8 mm**

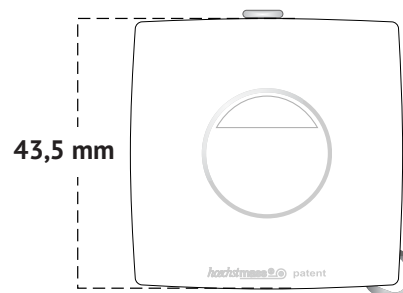
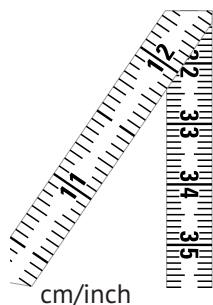
Scale







	Verpackung Packaging	Beschreibung Description	VPE Unit	Umkarton Export unit	Skala Scale	Artikel Reference
	bulk	box assorted colours	10	400	cm/inch	76203
	DP 14	Display with 14 pcs., assorted colours	1 set	10 sets	cm/inch	76242/14

Farben / Colours









- 
 Bestseller Rollmaßband rollfix, das Original seit über 40 Jahren! Erhältlich in 9 kräftigen Farben und im Display mit 10 oder 14 Stück zur Präsentation im Ladengeschäft. Schlagfestes ABS-Gehäuse mit patentierter Stop & Go Aufroll-Automatik, zuverlässig und bewährt.
- 
 Bestseller roller tape measure rollfix, the original for over 40 years! Available in 9 bright colors and in a display with 10 or 14 pieces for presentation in the store. Impact-resistant ABS case with patented Stop & Go automatic retractor, reliable and proven.
- 
 Le mètre ruban enrouleur de poche le plus vendu depuis 40 ans. Disponible en 9 coloris solides, soit en vrac ou pour la présentation dans le magasin en présentoir avec 10 ou 14 pcs. Boîtier en plastique ABS résistant aux chocs, enrouleur automatique breveté Stop & Go, fiable et éprouvé.
- 
 Nuestro „bestseller“, cintas métricas enrollable rollfix, el original desde más de 40 años. Disponible e 9 colores brillantes y en un display de 10 o 14 piezas, para presentación en el mostrador de su tienda. La carcasa es de ABS y por eso resistentes a golpes, además tiene un retractor automatic stop & go patentado, fiable y acreditado.

Length **150 cm / 60 inch**

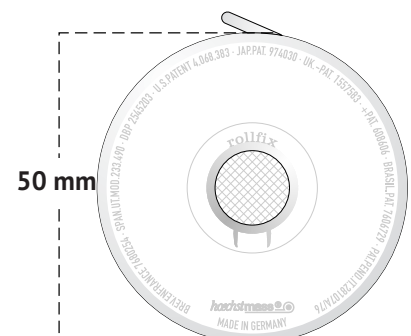
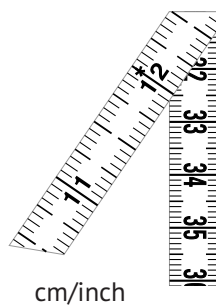
Width **10 mm**

Scale







	Verpackung Packaging	Beschreibung Description	VPE Unit	Umkarton Export unit	Skala Scale	Artikel Reference
	bulk	box assorted colours	10	560	cm/cm cm/inch	80103 80203
	SB	self service blister-card assorted colours	5	120	cm/cm cm/inch	80106 80206
	DP 14	Display with 14 pcs., assorted colours	1 set	10 sets	cm/cm cm/inch	80142/14 80242/14
	DP 10	Display with 10 pcs., assorted colours	1 set	40 sets	cm/cm cm/inch	80142/10 80242/10

Farben / Colours





- 
 Spezielles Maßband um Durchmesser zu ermitteln. Anwendung zum Beispiel in der Lebensmittelindustrie. Eine Seite cm-mm oder inch-Skala, andere Seite mit 43 cm \varnothing oder 18 1/100 inch \varnothing . Schlagfestes ABS-Gehäuse mit patentierter Stop & Go Aufroll-Automatik, zuverlässig und bewährt.
- 
 Special tape measure to determine diameter. Application for example in the food industry. One side cm-mm or inch scale, other side with 43 cm \varnothing or 18 1/100 inch \varnothing . Impact-resistant ABS case with patented Stop & Go automatic retractor, reliable and proven.
- 
 Un mètre ruban enrouleur spécialement pour mesurer le diamètre. Application par exemple dans l'industrie alimentaire. Ruban avec l'échelle de cm-mm ou inch, l'autre face avec le résultat de diamètre du produit mesuré. Le diamètre se détermine jusqu'à 43 cm \varnothing respectivement 18 1/100 inch \varnothing . Boîtier en plastique ABS résistant aux chocs, enrouleur automatique breveté Stop & Go, fiable et éprouvé.
- 
 Cintas métricas enrollable especialmente para la determinación del diámetro. La aplicación por ejemplo se usa la industria alimentaria. Una cara de la cinta es en cm-mm o inch, la otra cara con 43cm \varnothing 18 1/100 inch \varnothing . La carcasa es de ABS y por eso resistentes a golpes, además tiene un retractor auto-matic stop & go patentado, fiable y acreditado.

Length **150 cm / 60 inch**

Width **10 mm**

Scale

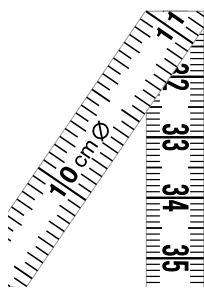

cm / \varnothing cm

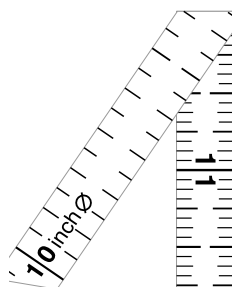

inch / \varnothing inch

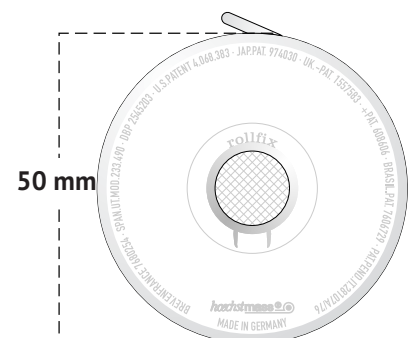





	Verpackung Packaging	Beschreibung Description	VPE Unit	Umkarton Export unit	Skala Scale	Artikel Reference
	bulk	box assorted colours	10	560	cm/cm ☒ cm/inch ☒	80103-DIA 80203-DIA

Farben / Colours





-  Rollmaßband rondo für den professionellen Gebrauch in handlicher Größe von 5 cm und großem Druckknopf zur Rückführung des Bandes in das Gehäuse! Erhältlich in schwarz, blau und rot. Schlagfestes ABS-Gehäuse mit patentierter Stop & Go Aufroll-Automatik, zuverlässig und bewährt.
-  Roller tape measure rondo for professional use in a handy size of 5 cm and large press button to return the tape into the case! Available in black, blue and red. Impact-resistant ABS case with patented Stop & Go automatic retractor, reliable and proven.
-  Mètre enrouleur automatique pour l'usage professionnel dans un format pratique de 5 cm et un grand bouton poussoir pour retourner le ruban dans le boîtier! Disponible en noir, bleu et rouge. Boîtier en plastique ABS résistant aux chocs avec enrouleur automatique breveté Stop & Go, fiable et éprouvé.
-  Cintas métricas enrollable rondo para un uso profesional en un tamaño práctico de 5cm, con un botón pulsador grande para enrollar automáticamente la cinta en la carcasa. Disponilbe en color negro, azul y rojo. La carcasa es de ABS y asi resistentes a golpes, además tiene un retractor automatic stop & go patentado, fiable y acreditado.

Length 150 cm / 60 inch

Width 15 mm

Scale

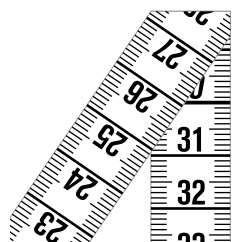



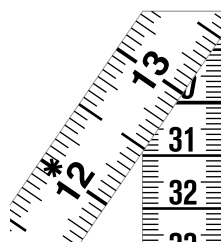

cm/cm

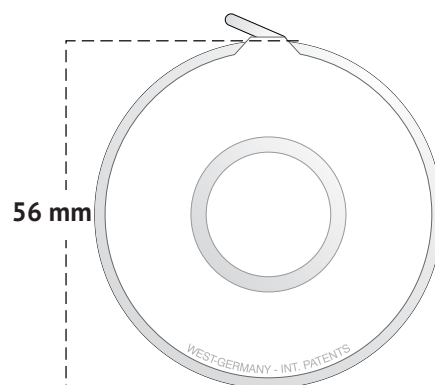

cm/inch



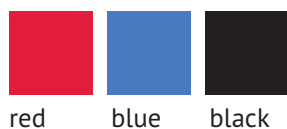

	Verpackung Packaging	Beschreibung Description	VPE Unit	Umkarton Export unit	Skala Scale	Artikel Reference
	bulk	box assorted colours	10	100	cm/cm cm/inch	82103 82203
	SB	self service blister-card assorted colours	5	120	cm/cm cm/inch	82106 82206
	DP 14	Display with 14 pcs., assorted colours	1 set	10 sets	cm/cm cm/inch	82142/14 82242/14
	DP 10	Display with 10 pcs., assorted colours	1 set	10 sets	cm/cm cm/inch	82142/10 82242/14

Farben / Colours





- 

3 Meter langes Maßband. Gehäuse in einer Farbkombination aus purpur und fuchsia, mit Umhängeband oder Schlüsselkette. Eine Bandseite hat immer analog-Skala, die andere wahlweise mit cm-mm oder inch. Schlagfestes ABS-Gehäuse mit patentierter Stop & Go Aufroll-Automatik, zuverlässig und bewährt.
- 

3 meters long tape measure. Case in a color combination of purple and fuchsia, with neck strap or key chain. One side of the tape always has an analogue scale, with either cm-mm or inch on the other side. Impact-resistant ABS case with patented Stop & Go automatic retractor, reliable and proven.
- 

Mètre ruban de 3 mètres de longueur. Boîtier dans une combinaison de couleurs pourpre et fuchsia, avec une bande textile ou une chaîne métallique qui peut servir comme porte-clés. Une face du ruban avec la graduation analogique, et l'autre soit avec échelle cm-mm ou inch. Boîtier en plastique ABS résistant aux chocs avec enrouleur automatique breveté Stop & Go, fiable et éprouvé.
- 

Cintas métricas enrollable de 3 metros de longitud. Carcasa de dos colores púrpura y fuchsia, con correa al cuello o de llavero. Una cara tiene una escala análogica con cm-mm o inch, en la otra. La carcasa es de ABS y así resistentes a golpes, además tiene un retractor automatic stop & go patentado, fiable y acreditado.

Length 300 cm / 120 inch

Width 15 mm

Scale







cm/analog

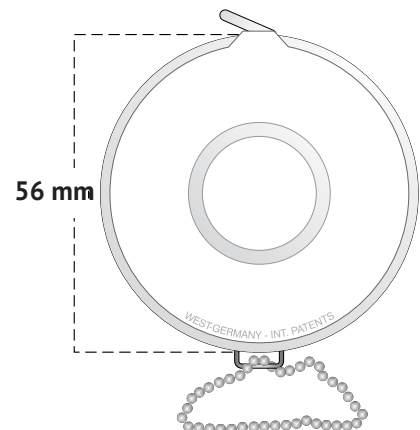

inch/analog





	Verpackung Packaging	Beschreibung Description	VPE Unit	Umkarton Export unit	Skala Scale	Artikel Reference
with key chain						
	bulk	box assorted colours	10	100	cm/analog inch/analog	83503 83603
	SB	self service blister-card assorted colours	5	60	cm/analog inch/analog	83506 83606
	DP 14	Display Set with 14 pcs. assorted colours	1 set	10 sets	cm/analog inch/analog	83542 83642
with neck strap						
	bulk	box assorted colours	10	100	cm/analog inch/analog	83503C 83603C
	SB	self service blister-card assorted colours	5	60	cm/analog inch/analog	83506C 83606C

Farben / Colours





- 

Neues Rollmaßband in handlicher Gehäusegröße von knapp 6 cm mit einem 200 cm langem Maßband, 12 mm breit. Hochwertiges Polyfiber Maßband, beidseitig weiß, mit einem D-Ring Beschlag. Schlagfestes ABS-Gehäuse mit transparenter Linse.
- 

New roller tape measure in handy case size of almost 6 cm with a 200 cm long tape measure and 12 mm width. High-quality polyfiber measuring tape, white on both sides, with a D-ring fitting. Impact-resistant ABS case with transparent lens.
- 

Nouveau mètre enrouleur automatique d'une longueur de 200 cm et 12 mm de largeur. Avec un diamètre de moins de 6 cm c'est encore en format-poche. Le ruban, blanc sur les deux faces, est en polyfibre de haute qualité. On sort le ruban du boîtier à l'aide d'un anneau métallique. Boîtier en plastique ABS résistant aux chocs avec enrouleur automatique et lentille transparente.
- 

Una cinta métrica enrollable nueva con 200 cm de longitud y 12 mm de ancho en un tamaño práctico de unos 6 cm aproximadamente. La cinta es de una selecta calidad de polifibra y color blanco en ambas caras. Con un anillo D de herraje. Carcasa de ABS resistente a golpes con inserto transparente.

Length **200 cm / 80 inch**

Width **12 mm**

Scale

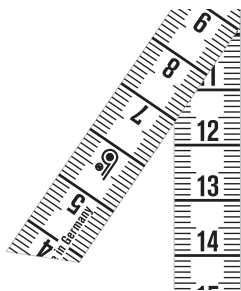

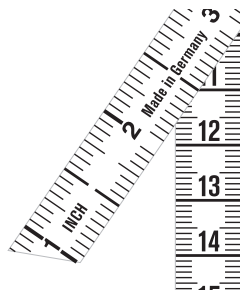

cm/cm

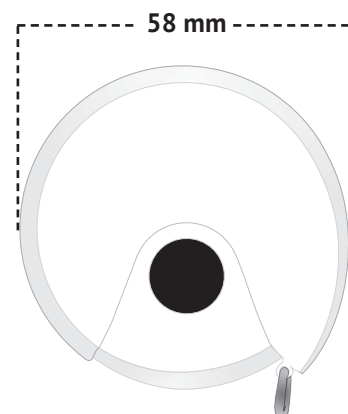

cm/inch





	Verpackung Packaging	Beschreibung Description	VPE Unit	Umkarton Export unit	Skala Scale	Artikel Reference
	bulk	box assorted colours	6	60	cm/cm cm/inch	73102 73202
	DP 14	Display with 14 pcs., assorted colours	1 set	10 sets	cm/cm cm/inch	73142 73242

Farben / Colours





- 

Rollmaßband mit praktischer Bandeinhängung am Gehäuse zum einfachen Messen von Körperumfängen oder anderen Umfängen. Handliche Form mit ca. 7,5 x 6 cm Größe. Schlagfestes ABS-Gehäuse mit patentierter Stop & Go Aufroll-Automatik, zuverlässig und bewährt.
- 

Roller tape measure with practical suspension device on the case for easy measurement of body circumference or other circumferences. Handy shape with approx. 7.5 x 6 cm size. Impact-resistant ABS case with patented Stop & Go automatic retractor, reliable and proven.
- 

Mètre enrouleur automatique avec système d'accrochage pour mesurer facilement la circonférence. Format pratique d'environ 7,5 x 6 cm. Boîtier en plastique ABS résistant aux chocs avec enrouleur automatique breveté Stop & Go, fiable et éprouvé.
- 

Cinta métrica enrollable con una fijación en la carcasa eso facilita las medidas de conturas. Una forma práctica de manejar. Tamaño de unos 7,5 x 6cm. La carcasa es de ABS y así resistentes a golpes, además tiene un retractor automatic stop & go patentado, fiable y acreditado.

Length **150 cm / 60 inch**

Width **15 mm**

Scale



cm/cm



analog/analog

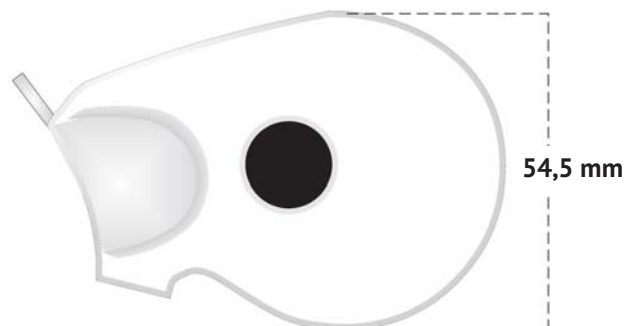

54,5 mm



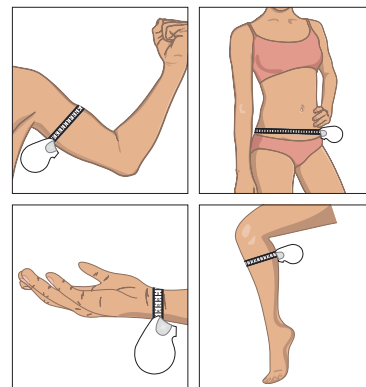

	Verpackung Packaging	Beschreibung Description	VPE Unit	Umkarton Export unit	Skala Scale	Artikel Reference
	bulk	box assorted colours	6	60	cm/cm analog/analog	85103 85403
	SB	self service blister-card assorted colours	5	60	cm/cm analog/analog	85106 85406
	DP 14	Display with 14 pcs., assorted colours	1 set	6 sets	cm/cm analog/analog	85142 85442

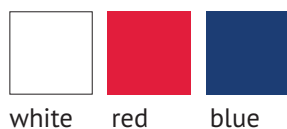

Farben / Colours





-  200 cm langes Maßband in 7,5 cm großen Gehäuse. Schlagfestes ABS-Gehäuse mit patentierter Stop & Go Aufroll-Automatik, zuverlässig und bewährt.
-  200 cm long tape measure in 7.5 cm case. Impact-resistant ABS case with patented Stop & Go automatic retractor, reliable and proven.
-  Mètre enrouleur automatique de 200 cm de longueur dans un boîtier de 7,5 cm. Boîtier en plastique ABS résistant aux chocs avec enrouleur automatique breveté Stop & Go, fiable et éprouvé.
-  Cintas métricas enrollable de 200cm de longitud en una carcasa de 7,5cm. La carcasa es de ABS y asi resistentes a golpes, además tiene un retractor automatic stop & go petentado, fiable y acreditado.

Length 200 cm / 80 inch

Width 15 mm

Scale



cm/analog



inch/analog

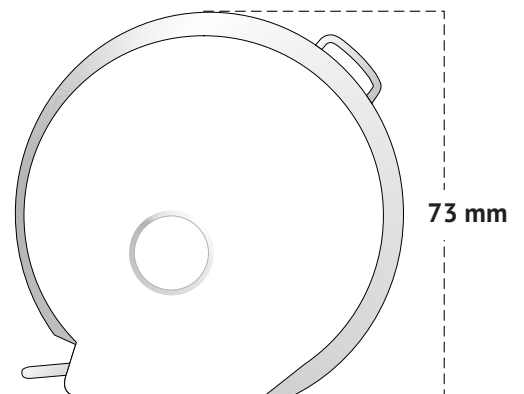



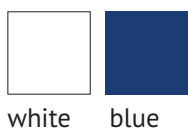

	Verpackung Packaging	Beschreibung Description	VPE Unit	Umkarton Export unit	Skala Scale	Artikel Reference
	bulk	box	6	60	cm/analog	97503
					inch/analog	97603

Farben / Colours





-  Flexibles Maßband in hochwertigem Metallgehäuse (Messing vernickelt) und 150 cm Länge. Automatischer Bandeinzug per Knopfdruck dank patentierter Stop & Go Aufroll-Automatik, zuverlässig und bewährt.
-  Flexible tape measure in high-quality metal case (nickel-plated brass) and 150 cm in length. Automatic tape retraction with the push of a button thanks to the patented Stop & Go automatic retractor, reliable and proven.
-  Mètre enrouleur automatique en boîtier métallique de haute qualité (laiton nickelé) avec un ruban de 150 cm respectivement 60 inch de longueur. Rétraction automatique du ruban par simple pression sur le bouton rétracteur automatique breveté Stop & Go, fiable et éprouvé.
-  Cintas métricas enrollable flexible de una longitud de 150cm, en carcasa metálica de una calidad muy alta (latón niquelado). Con un botón pulsador retractor automatic stop & go patentado, fiable y acreditado

Length 150 cm / 60 inch

Width 10 mm

Scale

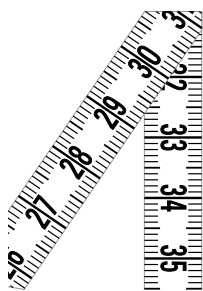

cm/cm



cm/inch

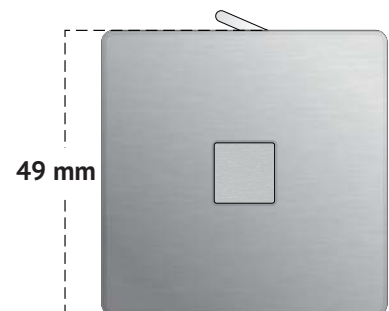



49 mm

	Verpackung Packaging	Beschreibung Description	VPE Unit	Umkarton Export unit	Skala Scale	Artikel Reference
	EZ	single box	1	50	cm/cm cm/inch	87103 87203
	DP	Display-Set with 6 pieces	1 set	4 sets	cm/cm cm/inch	87142 87242



- 

In Leder eingenähtes Maßband mit 150 cm Länge, wahlweise in schwarz oder rot. Automatischer Bandeinzug per Knopfdruck dank patentierter Stop & Go Aufroll-Automatik, zuverlässig und bewährt.
- 

Tape measure sewn in leather measuring tape with 150 cm length, optionally in black or red leather. Automatic tape retraction with the push of a button thanks to the patented Stop & Go automatic retractor, reliable and proven.
- 

Mètre ruban enrouleur automatique en boîtier de cuir véritable, Coloris du cuir: rouge ou noir. Longueur du mètre ruban: 150 cm. Rétraction automatique du ruban par simple pression sur le bouton rétracteur automatique breveté Stop & Go, fiable et éprouvé.
- 

Cintas métricas enrollable con una longitud de 150cm, en carcasa forrada de cuero, en los colores negro o rojo. Con un botón pulsador retractor automatic stop & go patentado, fiable y acreditado

Length 150 cm / 60 inch

Width 10 mm

Scale

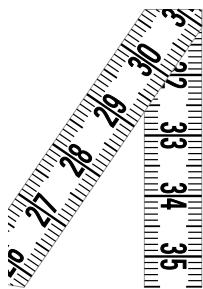

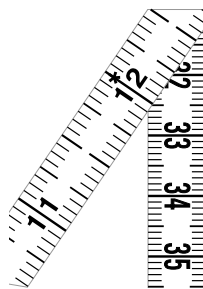

cm/cm

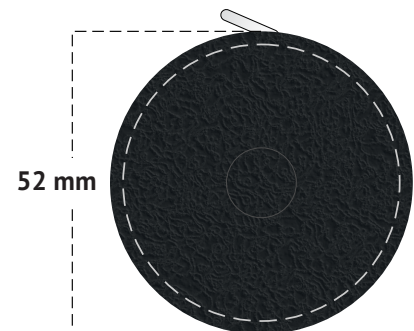

cm/inch

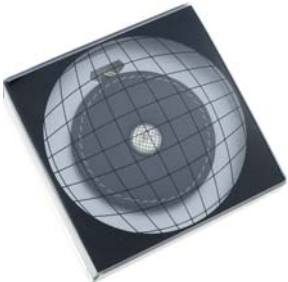

	Verpackung Packaging	Beschreibung Description	VPE Unit	Umkarton Export unit	Skala Scale	Artikel Reference
	EZ	single box	1	50	cm/cm cm/inch	88103 88203
	DP	Display-Set with 6 pieces	1 set	4 sets	cm/cm cm/inch	88142 88242



mastertape

81103 cm/cm
81203 cm/inch

lose in Schachtel à 10 Stück
sortierte Farben

bulk in box of 10 pieces
assorted colours

prisma

89103 cm/cm
89203 cm/inch

lose in Schachtel à 10 Stück
sortierte Farben

bulk in box of 10 pieces
assorted colours



Length 150 cm / 60 inch

Width 10 mm

Scale mastertape / prisma / hexagon

strato

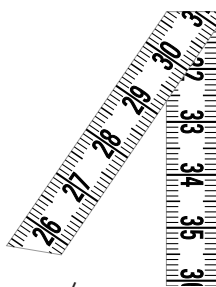

cm/cm



cm/inch



cm/inch



strato

92203 cm/inch

lose in Schachtel à 12 Stück
Gehäuse + Platine weiß
Druckknopf schwarz

bulk in box of 12 pieces
case + center disc white
press-button black





hexagon

86103 cm/cm
86203 cm/inch





lose in Schachtel à 10 Stück
sortierte Farben

bulk in box of 10 pieces
assorted colours



-  Hochwertige Maßbänder in Polyfiber-Qualität, Gehäuse in variabler Form und Farbe. Patentierte Stop & Go Aufroll-Automatik, zuverlässig und bewährt.
-  High-quality tapes in polyfiber quality, case in variable shape and color. Patented Stop & Go automatic retractor, reliable and proven.
-  Mètres enrouleurs automatiques avec ruban de haute qualité polyfibre, boîtier de forme et de couleur différente. Enrouleur automatique breveté Stop & Go, fiable et éprouvé.
-  Cintas de alta calidad en calidad de polifibra, carcasas en forma y colores variables. Retractor automático patentado Stop & Go, confiable y probado.





-  Preiswertes Rollmaßband für den allgemeinen medizinischen Gebrauch. Eine Seite mit cm-Skala und grünen, gelben und roten Farbflächen, die Auskunft über das Gesundheitsrisiko geben. Gelbe Seite wahlweise mit cm-Skala oder inch. Schlagfestes Gehäuse mit patentierter Stop & Go Aufroll-Automatik, zuverlässig und bewährt.
-  Low-cost roller tape measure for general medical use. One side with cm scale and green, yellow and red colored areas that give information about the health risk. Yellow side optionally with cm-scale or inch. Impact-resistant case with patented Stop & Go automatic retractable, reliable and proven.
-  Mètre enrouleur économique pour usage médical. Une face du ruban avec une échelle de cm et des zones de couleur verte, jaune et rouge qui donnent des informations sur les risques de santé. La face jaune avec graduation cm-mm ou inch. Boîtier résistant aux chocs avec système automatique rétractable breveté Stop & Go, fiable et éprouvé.
-  Cinta métrica enrollable económica para el uso en sanidad. La cinta tiene cara con una escala de cm y repartida en franjas de color verde, amarillo y rojo que así advierten del riesgo de insalud. La otra cara de color amarillo, que ser en cm o inch. La carcasa es de ABS y así resistentes a golpes, además tiene un retractor automatic stop & go patentado, fiable y acreditado.

Length **150 cm / 60 inch**



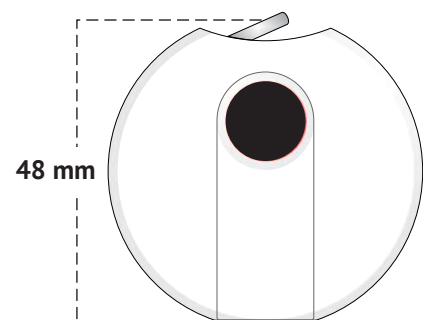
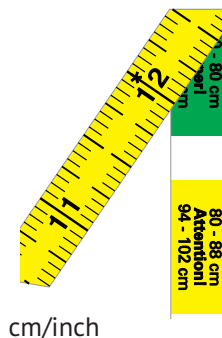
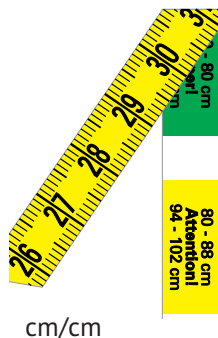

Width **10 mm**

Scale



	Verpackung Packaging	Beschreibung Description	VPE Unit	Umkarton Export unit	Skala Scale	Artikel Reference
	bulk	box	12	120	cm/cm cm/inch	92103-MED 92203-MED



-  Körper- und Umfangmaß forma BMI mit Einhängvorrichtung zur leichten Ermittlung des Messwertes. Zusätzlich BMI-Scheibe (Body-Mass-Index). Handliche Form mit ca. 7,5 x 6 cm Größe. Schlagfestes ABS-Gehäuse mit patentierter Stop & Go Aufroll-Automatik, zuverlässig und bewährt.
-  Body and circumference tape measure forma BMI with suspension device for easy determination of the measured value. Additional BMI disk (body mass index). Handy shape with approx. 7.5 x 6 cm size. Impact-resistant ABS case with patented Stop & Go automatic retractor, reliable and proven.
-  Mètre enrouleur automatique avec système d'accrochage pour mesurer des circonférences. En plus ce produit est garni d'un disque IMC (Indice de Masse Corporelle). Boîtier en plastique ABS résistant aux chocs avec enrouleur automatique breveté Stop & Go, fiable et éprouvé.
-  La complexión y las proporciones corporales forman el IMC, con esta cinta métrica y la fijación en la carcasa facilita la determinación del valor medido. Lleva un disco donde se puede comprobar el IMC (índice de masa corporal). Un forma práctica de usar con un tamaño aproximadamente de 7,7 x 6cm. La carcasa es de ABS y así resistentes a golpes, además tiene un retractor automatic stop & go patentado, fiable y acreditado.

Length **170 cm / 67 inch**

Width **15 mm**

Scale





cm/cm

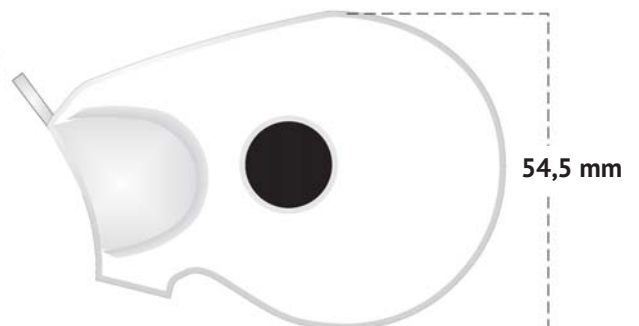

analog/analog





54,5 mm

	Verpackung Packaging	Beschreibung Description	VPE Unit	Umkarton Export unit	Skala Scale	Artikel Reference
	bulk	box	6	60	cm/cm analog	98103 98403
	TB	transparent box self-service	3	36	cm/cm analog	98144 98444



- 

200 cm langes Maßband in 7,5 cm großen Gehäuse mit BMI-Scheibe (Body-Mass-Index) zur Bewertung des Körpergewichts in Relation zur Körpergröße. Schlagfestes ABS-Gehäuse mit patentierter Stop & Go Aufroll-Automatik, zuverlässig und bewährt.
- 

200 cm long tape measure in 7.5 cm case with BMI disk (body mass index) to evaluate the body weight in relation to body size. Impact-resistant ABS case with patented Stop & Go automatic retractor, reliable and proven.
- 

Mètre enrouleur automatique d'une longueur de 200 cm dans un boîtier de 7,5 cm avec un disque IMC (indice de masse corporelle) permettant d'évaluer le poids corporel en relation à la taille. Boîtier en plastique ABS résistant aux chocs avec enrouleur automatique breveté Stop & Go, fiable et éprouvé.
- 

Cintas métricas enrollable de 200cm de largo en una carcasa de 7,5 cm con un disco IMC (índice de masa corporal) incorporado para evaluar el peso corporal en relación con el tamaño corporal. Carcas de ABS, a prueba de golpes, con el retractor patentado enrollable automático Stop & Go, eficaz y aprobado.

Length 200 cm / 80 inch

Width 15 mm

Scale

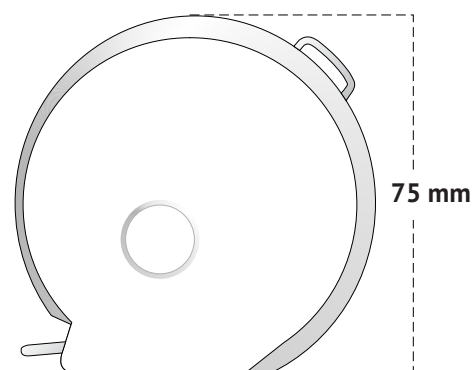



	Verpackung Packaging	Beschreibung Description	VPE Unit	Umkarton Export unit	Skala Scale	Artikel Reference
	bulk	box	6	60	cm/analog inch/analog	97103 97203



- 

Kleines Maßband in Bonbonpapier für den medizinischen Bereich speziell für die Bauchumfangmessung. Preiswertes, kleines Maßband geeignet für Mailings oder als give-away für Veranstaltungen und Messen! Band mit grünen, gelben und roten Farbfeldern, die ein Indikator für Herz-Kreislauf-Erkrankungen sein können.
- 

Small tape measure in candy wrapper for the medical field especially for the waist circumference measurement. Very inexpensive - suitable for mass mailings or as a give-away for events and fairs! Band with green, yellow and red swatches that can be an indicator of cardiovascular disease.
- 

Petit ruban à mesurer dans l'emballage de bonbons pour le domaine médical, en particulier pour mesurer le tour de taille. Très bon marché - convient pour les envois de masse ou comme cadeau pour des événements et des salons! Ruban avec des surfaces vertes, jaunes et rouges pouvant être un indicateur de maladie cardiovasculaire.
- 

Cinta métrica de tamaño pequeño en envoltura de caramelos para el sector de sanidad. Especialmente para la medida del abdomen. Super económico, idóneo para envíos en cantidad masiva, por ejemplo como regalo de eventos y ferias. La cinta conlleva una cara con indicadores en verde, amarillo o rojo que pueden alertar sobre la enfermedad cardiovascular.

Length **150 cm / 60 inch**

Width **10 mm**

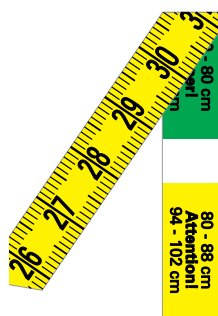

Scale



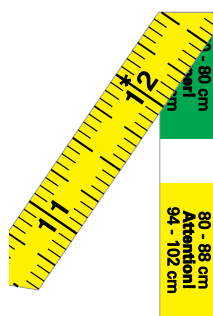

cm/cm



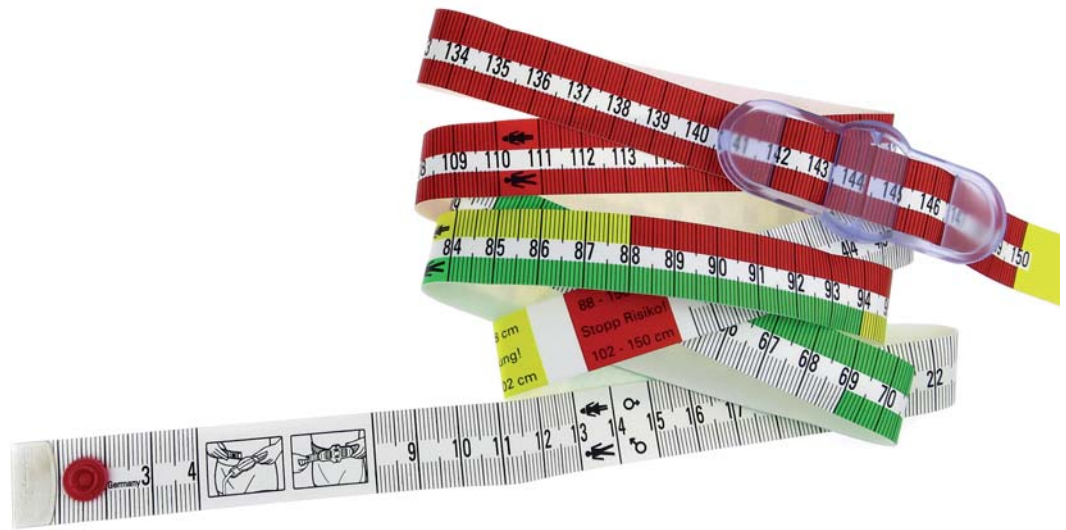
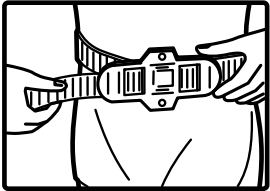
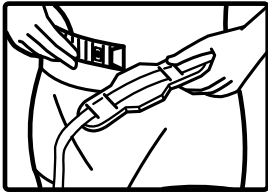

cm/inch

	Verpackung Packaging	Beschreibung Description	VPE Unit	Umkarton Export unit	Skala Scale	Artikel Reference
	bulk	polybag with candy wrapper assorted colours	100	500	cm/cm cm/inch	32103 32203
	DP 100	candy jar with candy wrapper assorted colours	1 set	14 sets	cm/cm cm/inch	32142 32242



- 

Hochwertiges Maßband mit patentiertem Messschieber für die Bauchumfangmessung. Mithilfe des Schiebers kann der Umfang durch den Benutzer ganz einfach selbst bestimmt werden. Band mit grünen, gelben und roten Farbfeldern, die ein Indikator für Herz-Kreislauf-Erkrankungen sein können. Hochwertiges Poly-Fibre Gewebe mit Metallbeschlügen an beiden Bandenden und Druckknopf-Verschluss am Messschieber.
- 

High-quality tape measure with patented slider for waist measurement. By using the slider the circumference can easily be determined by the user himself. Tape with green, yellow and red areas that can be an indicator of cardiovascular disease. High-quality poly-fiber fabric with metal tips on both ends and push-button closure on the slider.
- 

Ruban à mesurer de haute qualité avec une glissière brevetée pour mesurer le tour de taille. À l'aide de la glissière, l'utilisateur peut facilement déterminer son tour de taille lui-même. Ruban avec des surfaces vertes, jaunes et rouges étant un indicateur de maladie cardiovasculaire. Ruban en poly-fibre de haute qualité avec des fins métalliques aux deux bouts et une fermeture à bouton-poussoir sur la glissière.
- 

Cinta métrica de alta calibre con vernier patentado, para medir la cintura. Con el deslizante se puede fácilmente autodeterminar la medida. La cinta conlleva una cara con indicadores en verde, amarillo o rojo que pueden advertir sobre la enfermedad cardiovascular. El material de la cinta es de una calidad alta de poli-fibra, los extremos de la cinta son reforzados metálicos y un broche en el deslizante.

Length **150 cm / 60 inch**

Width **18.5 mm**

Scale





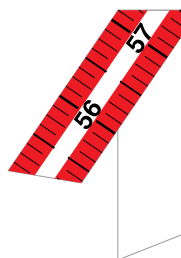

cm







inch

	Verpackung Packaging	Beschreibung Description	VPE Unit	Umkarton Export unit	Skala Scale	Artikel Reference
	bulk	rolled with elastic	10	200	cm inch	58103 58203



-  Kreideminen-Set zum Markieren und Anzeichnen auf Textilien und anderen Materialien. Neben exakten Strichmarkierungen sind auch genaue Punktmarkierungen auf verschiedenen Oberflächen möglich. Die Minen sind bruchsicher verpackt, sparsam in der Anwendung und durch den patentierten Haltemechanismus leicht zu wechseln. Vor Gebrauch unbedingt die Mine an einem Musterstück testen um sicherzustellen, dass sich die Markierungen mit dem Radiergummi entfernen lassen. Rückstände können ebenfalls mit einem feuchten Tuch entfernt werden. Entfernen der Markierungen muss in jedem Fall vor der Weiterbehandlung wie z.B. Bügeln, Waschen oder chemischer Reinigung erfolgen!
-  Chalk cartridge set for marking on textiles and other materials. In addition to exact line markings, precise point markings on different surfaces are also possible. The cartridges are safely packed, economical to use and easy to change thanks to the patented holding mechanism. Before use, be sure to test the cartridge on a specimen to make sure the markers can be removed with the eraser. Residues can also be removed with a damp cloth. In any case, removal of the markings must be done prior to further processing cartridge such as e.g. Ironing, washing or dry cleaning!
-  Jeu de craie pour le marquage sur des textiles et des autres matériaux. Avec ces mines de craie on fait des marques de lignes exactes et de points précis sur des surfaces diverses. Les mines sont incassables, économiques et faciles à changer grâce au mécanisme de retenue breveté. Avant l'utilisation, il faut tester les mines de craie sur un échantillon du matériel que vous allez utiliser pour vous assurer que les marques peuvent être retirées avec la gomme. Les résidus peuvent également être éliminés avec un chiffon humide. Dans tous les cas, le retrait des marquages doit être effectué avant tout traitement ultérieur, tel que p. ex. repassage, lavage ou nettoyage à sec!
-  Set de minas de tiza para marcar telas, y otros materiales. Se puede trazar líneas exactas y un punto en diferentes superficies. Las minas difícil de romper, económicas y muy fácil de cambiar, gracias a un mecanismo patentado de sujeción. Eso sí, antes de usarlos, asegúrese de probar en una muestra, si las marcas pueden ser borradas. La sobra de la tiza puede ser eliminada con un paño húmedo. En cualquier caso, las marcas deben ser eliminadas antes de continuar el procedimiento del material, como por ejemplo planchado, lavado o limpieza en seco !

	Verpackung Packaging	Beschreibung Description	VPE Unit	Umkarton Export unit	Artikel Reference
	etui	set with cartridge holder 17 col. cartridges 1 sharpener, 1 eraser in etui	10	100	41010
	SB	set with cartridge holder 17 col. cartridges 1 sharpener, 1 eraser self service blister card	5	60	41006
	refill SB	refill set 16 col. cartridges self service blister card	5	60	41106
	SB DP	display set with 12 pieces set on self service blister card	12	108	41042

Artikel auch mit wachshaltigen Minen erhältlich (so wie signet duo).
Für die Bestellung, die oben vermerkte Artikelnummer mit der
Endung "-2014" ergänzen.
Achtung: die Minen weisen andere Eigenschaften auf!

Article also available with waxy cartridges (like signet duo).
For the order, please add the extension "-2014" to the
above mentioned article.
Attention: the cartridges has different characteristics!

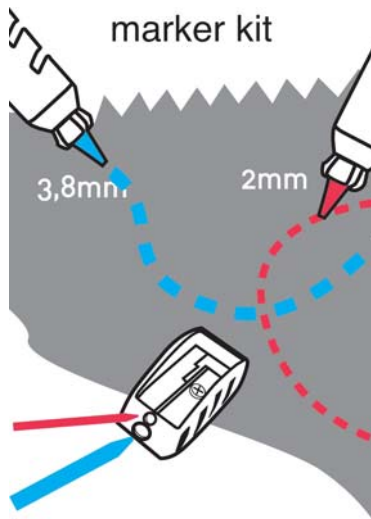

- Textilmarkier-Set zum Markieren und Anzeichnen auf Textilien und anderen Materialien mit 2 unterschiedlichen Minenstärken: 2 mm und 3,8 mm. Die Minen sind bruchsicher verpackt, sparsam in der Anwendung und durch den patentierten Haltemechanismus leicht zu wechseln.

Hinweis: Die Minen sind wachshaltig und unterscheiden sich zu den Minen des Kreideminen-Sets signet color. Vor Gebrauch unbedingt die Mine an einem Musterstück testen um sicherzustellen, dass sich die Markierungen mit dem Radiergummi entfernen lassen. Rückstände können ebenfalls mit einem feuchten Tuch entfernt werden. Entfernen der Markierungen muss in jedem Fall vor der Weiterbehandlung wie z.B. Bügeln, Waschen oder chemischer Reinigung erfolgen!

- Textile marker set for marking on textiles and other materials with 2 different thickness: 2 mm and 3.8 mm. The cartridges are safely packed, economical to use and easy to change thanks to the patented holding mechanism.

Note: The cartridges are safely packed, waxy and different from the cartridges of the chalk set signet color. Before use, be sure to test the cartridge on a specimen to make sure the markers can be removed with the eraser. Residues can also be removed with a damp cloth. In any case, removal of the markings must be done prior to further processing such as e.g. Ironing, washing or dry cleaning!

- Ensemble de marqueurs textiles pour le marquage de textiles et autres matériaux avec 2 tailles de mines différentes: 2 mm et 3,8 mm de diamètre. Les mines sont incassables, économiques et faciles à changer grâce au mécanisme de retenue breveté.





Remarque: ces mines sont cireuses et réagissent différemment que les mines de l'article signet color. Avant l'utilisation, il faut tester les mines de craie sur un échantillon du matériel que vous allez utiliser pour vous assurer que les marques peuvent être retirées avec la gomme. Les résidus peuvent également être éliminés avec un chiffon humide. Dans tous les cas, le retrait des marquages doit être effectué avant tout traitement ultérieur, tel que p. ex. repassage, lavage ou nettoyage à sec!





- Set de marcadores textiles para marcar telas y otros materiales. La mina tiene 2 clases de espesor, de 2mm y 3,8mm. Las minas muy resistentes, económicas y muy facil de cambiar, gracias a un mecanismo patentado de sujeción.

El indicio: Las minas son de un material de cera. Y se diferencian al set de minas de color. Antes de usarlos, asegúrese de probar en una muestra, si las marcas pueden ser borrados. La sobra de la tiza puede ser eliminada con un paño humedo. En cualquier caso, las marcas deben ser eliminadas antes de continuar el procedimiento del material, como por ejemplo planchado, lavado o limpieza en seco!

	Verpackung Packaging	Beschreibung Description	VPE Unit	Umkarton Export unit	Artikel Reference
	etui	set with cartridge holder 16 col. cartridges 1 sharpener, 4 eraser in etui	10	100	41010-3820
	SB	set with cartridge holder 16 col. cartridges 1 sharpener, 4 eraser self service blister card	5	60	41006-3820
	SB refill	refill-set 16 col. cartridges self service blister card	5	60	41106-3820
	SB-DP	display set set on self service blister card	12	108	41042-3820







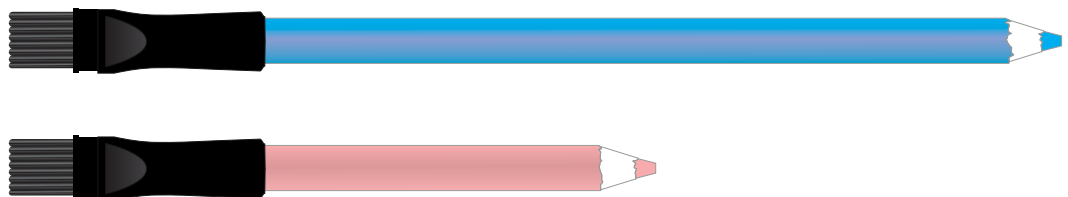

-  Schneiderkreidestifte zum Markieren und Anzeichnen auf Textilien und anderen Materialien. Stift mit Radierbürste in den Längen 11 cm und 17 cm und den Farben pink, blau und weiß. Entweder lose verpackt oder alternativ farblich sortiert auf SB-Karte und mit Spitzer. Vor Gebrauch unbedingt die Mine an einem Musterstück testen um sicherzustellen, dass sich die Markierungen mit dem Radiergummi entfernen lassen. Rückstände können ebenfalls mit einem feuchten Tuch entfernt werden. Entfernen der Markierungen muss in jedem Fall vor der Weiterbehandlung wie z.B. Bügeln, Waschen oder chemischer Reinigung erfolgen!
-  Dressmarker pencil for marking on textiles and other materials. Pen with eraser brush in the lengths 11 cm and 17 cm and the colors pink, blue and white. Either loosely packed or assorted colours on blister card on SB card and with sharpener. Before use, be sure to test the marking on a specimen to make sure the markers can be removed with the eraser. Residues can also be removed with a damp cloth. In any case, removal of the markings must be done prior to further processing such as e.g. Ironing, washing or dry cleaning!
-  Crayons de tailleur pour le marquage sur des textiles et d'autres matériaux. Crayon avec gomme à effacer, dans les longueurs de 11 cm et 17 cm, dans les coloris rose, bleu et blanc. En vrac ou sur carte blister en coloris assortis et avec un taille-crayon. Avant l'utilisation, testez sur un échantillon de tissu pour vous assurer que les marques peuvent être retirées avec la gomme. Les résidus peuvent également être éliminés avec un chiffon humide. Dans tous les cas, le retrait des marquages doit être effectué avant tout traitement ultérieur, tel que p. ex. repassage, lavage ou nettoyage à sec!
-  Lápices de sastrería para marcar sobre textiles y otros materiales. Lápiz con un pincel borrador en la cabecera, disponibles en un 11cm y 17cm de largo y en los colores rosa, azul y blanco. Se pueden pedir sueltos o empaquetados en tarjeta SB de un color elegido y con sacapuntas. Antes de usarlos, asegúrese de probar en una muestra, si las marcas pueden ser borradas. La sobra de la tiza puede ser eliminada con un paño húmedo. En cualquier caso, las marcas deben ser eliminadas antes de continuar el procedimiento del material, como por ejemplo planchado, lavado o limpieza en seco !

	Verpackung Packaging	Beschreibung Description	VPE Unit	Umkarton Export unit	Color	Artikel Reference
11 cm						
	bulk	box white, blue, pink	100	2000	white blue pink	42001 W 42001 B 42001 P
	SB	2 pieces on self service blister-card white + blue / white + pink assorted	5	120	assorted	42006
						
17 cm						
	bulk	box white, blue, pink	100	500	white blue pink	43001 W 43001 B 43001 P
	SB	3 pieces on self service blister-card white: 17 cm long, blue + pink 11 cm long, with sharpener	5	120	assorted	43006
						











-  Wasserlöslicher Markier- und Zeichenstift für Stoffe. Anwendung zum Beispiel beim Nähen, Sticken, in der Seidenmalerei oder Patchwork. Lose verpackt oder auf SB-Karte mit Gummi gehalten (kein Blister).
Vor Gebrauch unbedingt an einem Musterstück testen um sicherzustellen, dass die Markierungen mit einem sauberen und nassen Tuch entfernt werden können. Entfernen der Markierungen muss in jedem Fall vor der Weiterbehandlung wie z.B. Bügeln, Waschen oder chemischer Reinigung erfolgen!
-  Water erasable marking and drawing pen for fabrics. Application for sewing, embroidery, silk painting or patchwork. Loosely packed or held on SB card with rubber (no blister).
Be sure to test on a specimen before use to ensure that the markings can be removed with a clean and wet cloth. In any case, removal of the markings must be done prior to further processing such as e.g. Ironing, washing or dry cleaning!
-  Feutre soluble dans l'eau. Application pour la couture, la broderie, la peinture sur du soie ou le patchwork. En vrac ou sur carte self service.
Testez-le sur un échantillon avant l'utilisation pour vous assurer que les marques s'enlèvent avec un chiffon propre et humide. Dans tous les cas, le retrait des marquages doit être effectué avant tout traitement ultérieur, tel que p. ex. repassage, lavage ou nettoyage à sec!
-  Rotulador soluble para telas. Aplicable en costura, bordados, pintura sobre seda y patchwork. Se pueden pedir sueltos o empaquetados en tarjeta SB con una goma (sin blister).
Antes de usarlos, asegúrese de probar en una muestra, si las marcas pueden ser borrados. La sobra de la tiza puede ser eliminada con un paño humedo. En cualquier caso, las marcas deben ser eliminadas antes de continuar el procedimiento del material, como por ejemplo planchado, lavado o limpieza en seco !

	Verpackung Packaging	Beschreibung Description	VPE Unit	Umkarton Export unit	Artikel Reference
	bulk	bulk packed	50	100	44001
	SB	self service card without blister	5	120	44006







- 
 Praktische Kombination aus Nahttrenner und Pinzette in einem. Die hochwertigen Instrumente lassen sich mit einer Fingerbewegung ausschieben und bleiben durch Kugelrasterung in Gebrauchsstellung fixiert. Schlagfestes Gehäuse mit 11 cm Länge, Werkzeuge aus vernickeltem Stahl.
- 
 Practical combination of seam ripper and tweezers in one. The high-quality instruments can be pushed out with one movement of the finger and remain fixed in the position of use by means of a ball grid. Impact-resistant case with 11 cm length, tools made of nickel-plated steel.
- 
 Combinaison pratique de découpeur et de pincettes. Les instruments de haute qualité peuvent être sortis avec un seul mouvement du doigt et restent en position à l'aide d'utilisation d'une grille à billes. Boîtier résistant aux chocs avec une longueur de 11 cm, outils en acier nickelé.
- 
 Una combinación muy práctica de soltacobusturas y pinzas de una calidad alta. Con un solo dedo se puede deslizar la pieza y permanece fija durante el uso mediante un mecanismo enclavador. La carcasa es de un material muy resistente y tiene una longitud de 11cm, las herramientas son de acero niquelado.

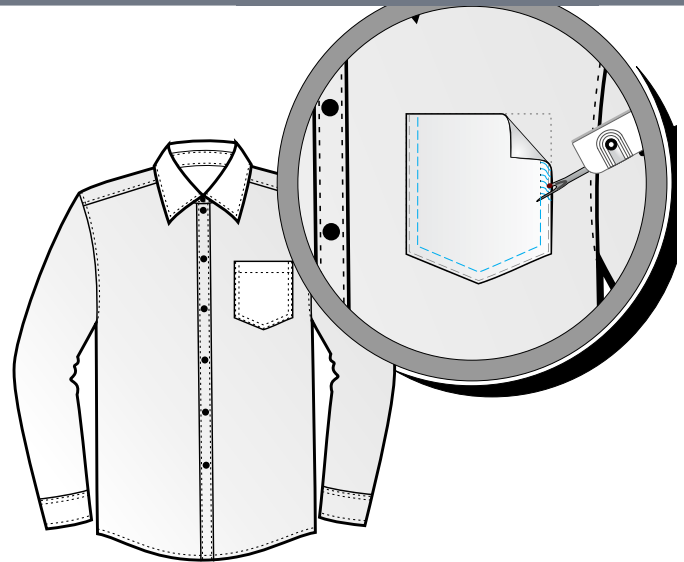

Size **11 x 1,4 x 0,9 cm**

	Verpackung Packaging	Beschreibung Description	VPE Unit	Umkarton Export unit	Artikel Reference
	bulk	pink turquoise 10 pcs. in polybag assorted colours	50	1.050	45001
	SB	pink turquoise self service blister- card assorted colours	5	120	45006
	DP 20	Display set with 20 pcs. assorted colours	1 Set	10 Set	45042



- 
 Hochwertiger Nahttrenner zum Auftrennen von Stoffnähten. Nach Benutzung ins das Gehäuse einklappen und sicher verwahren. Schlagfestes Gehäuse mit 7 cm Länge, Werkzeug aus vernickeltem Stahl.
- 
 High-quality seam ripper for cutting fabric seams. After use, fold into the case and store safely. Impact-resistant case with 7 cm length, tool made of nickel-plated steel.
- 
 Découpeur de haute qualité. Après utilisation, pliez-le dans le boîtier et rangez en toute sécurité. Boîtier résistant aux chocs, d'une longueur de 7 cm, outil en acier nickelé.
- 
 Un práctico soltacobsturas con una cuchilla pegable que se integra en la carcasa. Diferentes posibilidades de uso. La carcasa es resistente y el sujetador de la cuchilla se puede obtener en varios colores. La cuchilla del soltacobsturas es de acero (alta calidad).





Size **7 x 1,5 cm**

	Verpackung Packaging	Beschreibung Description	VPE Unit	Umkarton Export unit	Artikel Reference
	bulk	box assorted colours	36	2.016	46001
	SB	self service blister-card assorted colours	5	120	46006
	DP 36	Display-Set with 36 pcs. assorted colours	1 Set	10 Set	46042







- Klassischer Nahttrenner mit abnehmbarer Schutzkappe in zwei Größen: small 9 x 1,1 cm und large 12 x 1,2 cm. Der kleine Nahttrenner hat einen roten Klingenhalter, der große wird farblich sortiert geliefert. Hochwertige geschliffene Klinge und Pinzette aus vernickeltem Stahl.
- Classic seam ripper with removable protective cap in two sizes: small 9 x 1,1 cm and large 12 x 1,2 cm. The small seam separator has a red blade holder, the big one is delivered in different colors. High-quality polished blade and tweezers made of nickel-plated steel.
- Découseur classique avec capuchon de protection amovible en deux tailles: petit 9 x 1,1 cm et grand 12 x 1,2 cm. Le petit découseur a un porte-lame rouge, le grand est livré en coloris assortis. Lame polie de haute qualité.
- Un soltacosuras clásico con tapadera protectora extraíble, disponible en dos tamaños 9 x 1,1 cm y grande 12 x 1,2 cm. El soporte de la cuchilla del soltacosuras pequeño es en color rojo y del grande es disponible en varios colores. La cuchilla es pulida y de alta calidad.

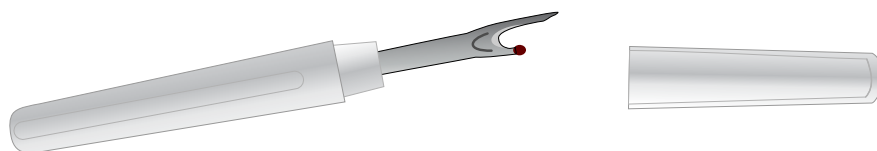

Size **small: 9 x 1,1 cm**
 large: 12 x 1,2 cm

	Verpackung Packaging	Beschreibung Description	VPE Unit	Umkarton Export unit	Artikel Reference
small					
	bulk	bulk packed transparent cap	240	240	47001
	SB	self service card, without blister	5	120	47006
large					
	bulk	bulk packed transparent cap assorted colours	120	120	48001
	SB	self service card, without blister assorted colours	5	120	48006









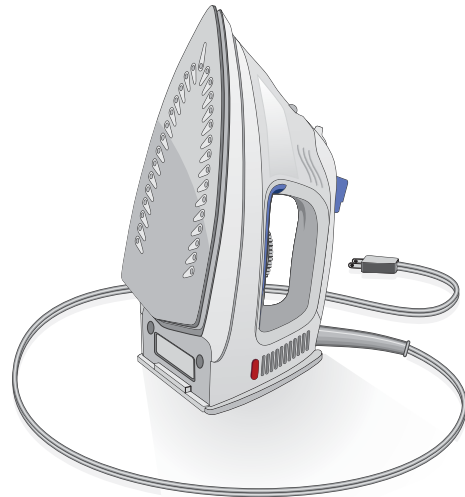

-  Farbloser Textilkleber für die schnelle Reparatur von Löchern, Rissen und losen Säumen. Verbindet schnell, sicher und dauerhaft Textilien, Leder, Gummi, Holz, Filz und Papier. Die Klebenahnt bleibt elastisch, ist waschmaschinenfest bis 60°C und bügelfest. Eine Tube enthält 42 Gramm. Der Klebstoff ist lösemittelhaltig. Unter Verschluss und für Kinder unzugänglich aufbewahren.
-  Colorless textile adhesive for quick repair of holes, cracks and loose seams. Connects textiles, leather, rubber, wood, felt and paper quickly, safely and permanently. The adhesive seam remains elastic, is machine washable up to 60 ° C and iron-proof. One tube contains 42 grams. The adhesive is solvent-based. Keep locked up and out of the reach of children.
-  Adhésif textile transparent pour la réparation rapide de trous, fissures et coutures défaits. Pour souder les textiles, le cuir, le caoutchouc, le bois, le feutre et le papier rapidement, en toute sécurité et de manière permanente. La couture adhésive reste élastique, lavable en machine à 60 ° C et au fer. Un tube contient 42 grammes. L'adhésif est à base de solvant. Conserver sous clef et hors de la portée des enfants.
-  Pegamento textil incoloro, para arreglos rápidos de agujeros, desgarros y costura sueltas. Interconecta textiles, cuero, goma, madera, fieltro y papel, de una forma rápida, segura y permanente. La costura pegada permanece elastic, es lavable hasta los 60C y resistente a la plancha. Un tubo contine 42 gramos. El pegamento tiene una base de solvene Manténgase cerrado y fuera del alcance de los niños.





	Verpackung Packaging	Beschreibung Description	VPE Unit	Umkarton Export unit	Artikel Reference
	bulk	carton	108	108	49001
	SB	self service blister-card	5	60	49006
	SB DP	self service blister-card in Display Box	10	90	49042



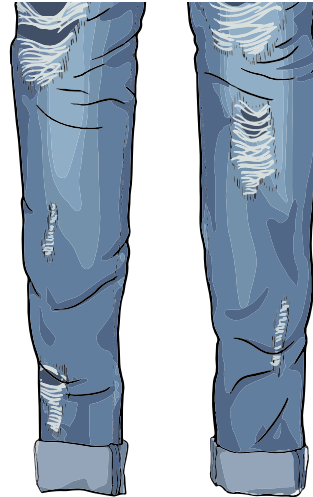

-  Der Bügeleisenreiniger ist ein spezieller Reinigungsstift zur Pflege jeder Bügeleisensole. Er reinigt und entkalkt alle Leichtgleit-Sohlen und erhöht zusätzlich die Gleitfähigkeit. Der Reiniger wird bei vorgeheiztem Bügeleisen auf die Sohle aufgetragen, wodurch er sich verflüssigt. Mit einem geeigneten Tuch können daraufhin Schmutz und Kalk entfernt werden. Zur Reinigung der Dampfauslässe wird in senkrechter Stellung kurz gedampft und nachgewischt. Nach der Behandlung gleitet das Bügeleisen wieder perfekt und leicht über den Stoff. Gebrauchsanleitung beiliegend.
-  The iron cleaner and descaler is a special cleaning pen for the care of the sole plate of every iron. It cleans and descales all easy-glide sole plates and also increases the irons capacity to glide smoothly. The cleaner is applied to the sole plate with a preheated iron; this liquefies the cleaner. A suitable cloth can then be used to remove dirt and calcium. To clean the steam nozzles, stand the iron in the vertical position and use the steam function for a short period, then wipe. After this treatment the iron once more glides with perfect ease over the fabric. Instructions attached.
-  Le nettoie-fer est un stick de nettoyage spécial pour l'entretien des semelles de fers à repasser. Il nettoie et détartre les semelles et augmente en plus la mobilité. Le nettoyant est appliqué sur la semelle du fer préchauffé, ce qui permet de le liquéfier. Utilisez un chiffon approprié pour enlever ensuite la saleté et le calcaire. Pour nettoyer les sorties vapeur, le fer est mis brièvement sur vapeur verticalement et essuyé. Après le traitement, le fer à repasser glisse parfaitement et en douceur sur le tissu. Instructions jointes.
-  Una barra para limpiar la suela de la plancha. Limpia y libera de cál la suela y así vuelve a hacer fácil el deslizamiento de esta. La plancha se precalenta algo y entonces se aplica la barra, el material se fluidifica algo sobre la suela. Con un paño limpio y adecuado se pasa por la suela y se elimina la suciedad y la cál. Para limpiar los agujeros de salida de vapor, se evapora brevemente en posición vertical. Después de este tratamiento, la plancha desliza de nuevo ligeramente sobre la tela. Instrucciones adjuntas.

	Verpackung Packaging	Beschreibung Description	VPE Unit	Umkarton Export unit	Artikel Reference
	bulk	bulk packed	40	40	50001
	SB	self service blister-card	5	60	50006



-  Spezielles Flickpulver zum Verschließen von Rissen und Löchern. Flicker werden mithilfe des tex repair auf den beschädigten Stoff gebügelt und so ganz einfach fixiert. Ohne Nähte und sauber verarbeitet, nahezu unsichtbar. Auch zum nähfreien Säumen kann das Flickpulver zum Einsatz kommen. Die sechs feinen Löcher im Deckel der Dose erlauben ein genaues Dosieren und Auftragen des Pulvers. In der Dose mit Dosierdeckel sind 12 g des Flickpulvers enthalten.
-  This textile repair powder provides an easy way to affix patches by ironing the affected fabric. Without seams and cleanly processed, these patches are virtually invisible. This bonding powder can be used for sew-free hemming. The six fine holes on the can's lid allow for precise powder dosage and application. The can with dosing lid contains 12 g of the textile repair powder.
-  La poudre thermocollante offre un moyen facile de fixer une pièce autocollante par repassage sur le tissu endommagé. Sans coutures et soigneusement travaillées, ces pièces autocollantes sont presque invisibles. La poudre peut être également utilisée pour ourler sans couture. Les six trous fins sur le couvercle de la boîte permettent un dosage exact et une application précise de la poudre. 12 g de poudre thermocollante dans la boîte avec couvercle doseur.
-  Un polvo especial para usar como parche y cerrar desgarres y agujeros en tals. El parche se coloca sobre la tela dañada y con el uso de los polvos tex se fija fácilmente. No hacen falta costuras, es una solución muy limpia, ya que estos parches son casi invisibles. También se pueden utilizar para hacer un dobladillo sin costura. La tapa está agujerada y esto hace posible una dosificación, y aplicación precisa. El envase contiene 12g de los polvos.

	Verpackung Packaging	Beschreibung Description	VPE Unit	Umkarton Export unit	Artikel Reference
	bulk	bulk packed	40	40	51001
	SB	self service blister-card	5	60	51006



golden bird

Nähset im Etui mit Schere, Fingerhut und rollfix Maßband

Sewing set in case with scissors, thimble and rollfix tape measure



minicure

Maniküre Set aus Nagelfeile und Pinzette (vernickelter Stahl)

Manicure set of nail file and tweezers (nickel plated steel)



tango

Lanyard aus Textilband, individuell in der Länge einstellbar

Lanyard made of textile strap, individually adjustable in length





bodyguard

Körper- und Umfangmaßband mit 150 cm und Gesundheitstips auf der Rückseite

Body and circumference tape measure with 150 cm and health tips on the reverse side



kindermeter

Messlatte für Kinder zum Aufkleben an die Wand, in 3 Motiven

Groth chart for children to stick to the wall, with 3 designs



Verkaufs- und Lieferbedingungen 1986

1. Angebote, Aufträge

Angebote sind unverbindlich und freibleibend. Aufträge werden nur mit Auftragsbestätigung des Lieferanten oder mit Lieferung der Ware verbindlich. Einkaufsbedingungen des Bestellers binden den Lieferanten nicht, auch wenn er ihnen nicht widersprochen hat.

2. Transport

Der Transport der Ware erfolgt auf Gefahr des Bestellers. Wenn nichts anderes vereinbart ist, trägt die Transportkosten der Besteller.

3. Gewährleistung, Haftung

Mängel der Ware – dazu gehören auch fehlende zugesicherte Eigenschaften – sind unverzüglich, spätestens 10 Tage nach Ankunft der Ware geltend zu machen. Der Lieferant kann mangelhafte Ware nachbessern, wobei er die Transportkosten zu tragen hat. Geht eine wiederholte Nachbesserung fehl, kann der Besteller den Vertrag rückgängig machen oder den Kaufpreis

herabsetzen; weitergehende Ansprüche hat er nicht, es sei denn er haftet für zugesicherte Eigenschaften der Ware.

Auch sonst haftet der Lieferant nur, wenn er vorsätzlich oder grob fahrlässig gehandelt hat. Geringfügige Abweichungen von Material, Druck oder Farbe sind produktionsbedingt und berechtigen nicht zu Ansprüchen seitens des Kunden.

4. Eigentumsvorbehalt

Der Lieferant behält sich das Eigentum an der gelieferten Ware bis zur vollen Bezahlung vor. Pfändungen und andere Zugriffe sind dem Lieferanten unverzüglich mitzuteilen.

5. Gerichtsstand, geltendes Recht

Ausschließlicher Gerichtsstand ist Frankfurt am Main, auch für Ansprüche des Lieferanten aus Wechseln oder Schecks.

Bei Auslandsgeschäften gilt ausschließlich das Recht der Bundesrepublik Deutschland.

General Conditions of Sale and/or Delivery 1987

1. Mere offers of SELLER shall have no binding force and may be subject to changes without special notice. Orders of PURCHASER shall only become binding either upon express confirmation from, or actual delivery of ordered goods by SELLER. Any terms of PURCHASER shall by no means apply to transactions due or allegedly due from SELLER, even if the latter did not contradict in an individual case.

2. Any delivery due from SELLER will by no other way be effected but at sole risk and cost of PURCHASER.

3. Any defects of goods delivered, no matter whether consisting of deviations from general or special quality standards expressly warranted by SELLER, shall immediately, in no case later than ten days upon arrival, be asserted to SELLER. SELLER shall then have the right of improving duly asserted defects, whereas PURCHASER shall have to bear costs unavoidably incurring for transport of goods in order to be improved by SELLER. If and when repeated improvement measures should fail to succeed, PURCHASER shall be entitled to cancel contract with retroactive effect, or to claim from SELLER that the original price be adequately reduced. PURCHASER shall only be entitled to damages, if SELLER, due to at least gross negligence, either did fail to perform, or if the goods delivered do show a quality standard below the one as set forth by SELLER in a special warrant. Minor deviations in material, printing or colour can occur in production and are not justification for customer complaints.

4. No other act which SELLER actually omitted, although committing such act was necessary for performance, shall nevertheless be construed as to establish SELLER'S liability under a contract unless such omission can clearly and necessarily be attributed to at least SELLER'S gross negligence.

5. Title to all goods delivered shall be and kept reserved to SELLER until full and final payment by PURCHASER. PURCHASER shall immediately notify SELLER of any attachment or similar measure of seizure brought about the goods delivered.

6. Amendments of a contract, in particular orally agreed changes, shall be null and void, unless confirmed by SELLER in writing.

7. Any disputes between SELLER and PURCHASER including those arising from bills of exchange and/or cheques signed by PURCHASER shall be brought to, and decided by the courts of Frankfurt on Main (FRG) as exclusive place of uniform jurisdiction.

Moreover, Sulzbach/Taunus (FRG), shall be the sole and exclusive place, where the mutual duties of both parties involved will have to be performed.

The law and statutes of the Federal Republic of Germany shall be governing, and apply to all and any transaction of and between both PURCHASER and SELLER.





hoechstmass balzer



*hoechst***mass**®

Specialist for tape measures since 1895

Hoechstmass Balzer GmbH
Wiesenstraße 13
65843 Sulzbach / Ts.
Germany

Tel: +49 (0)6196 - 50 05 0
Fax: +49 (0)6196 - 50 05 55

e-mail: info@hoechstmass.com
www.hoechstmass.com